



# Operating Instructions

---

**GEN24, Tauro, and Verto country setup menu**

**EN-US** | Operating instructions



42,0426,0413,EA

011-24062024



# Table of contents

General.....	4
Country setup.....	4
Requesting inverter codes in Solar.SOS .....	4
Adjusting parameters with the Fronius Solar.start app .....	5
Adjusting parameters with the browser .....	6
<b>Country setup</b> .....	<b>7</b>
Country setup selection.....	9
Country setup selection.....	9
General.....	10
Startup and Reconnection .....	10
Ramp rates .....	11
Safety .....	14
Unintentional islanding detection.....	14
Isolation monitoring.....	14
DC arc fault protection .....	16
RCMU .....	18
DC shutdown communication .....	19
Interface protection.....	20
Voltage .....	20
Frequency.....	23
DC injection.....	27
Grid support functions.....	29
Voltage fault ride through (VFRT).....	29
Active Power.....	41
Reactive power .....	63

# General

---

## Country setup

### **WARNING!**

#### **Danger due to unauthorized error analyses and repair work.**

This can result in serious injury and damage to property.

- ▶ Fault analyses and repair work on the photovoltaic system may only be carried out by installers/service technicians from authorized specialist companies in accordance with national standards and guidelines.
- 

### **NOTE!**

#### **Risk due to unauthorized access.**

Incorrectly set parameters can negatively influence the public grid and/or the inverter grid power feed operation, and lead to a loss of conformity with the standard.

- ▶ The parameters may only be adjusted by installers/service technicians from authorized specialist companies.
  - ▶ Do not give the access code to third parties and/or unauthorized persons.
- 

### **NOTE!**

#### **Risk due to incorrectly set parameters.**

Incorrectly set parameters can negatively influence the public grid and/or cause faults and failures on the inverter, and lead to the loss of conformity with the standard.

- ▶ The parameters may only be adjusted by installers/service technicians from authorized specialist companies.
  - ▶ The parameters may only be adjusted if the utility permits or requires this.
  - ▶ Only adjust the parameters taking into account the nationally applicable standards and/or directives and the specifications of the utility.
- 

The "Country Setup" menu area is intended exclusively for installers/service technicians from authorized specialist companies. To request the access code required for this menu area, see chapter [Requesting inverter codes in Solar.SOS](#).

The selected country setup for the respective country contains preset parameters according to the nationally applicable standards and requirements. Depending on local grid conditions and the specifications of the utility, adjustments to the selected country setup may be necessary.

---

## **Requesting inverter codes in Solar.SOS**

The "Country Setup" menu area is intended exclusively for installers/service technicians from authorized specialist companies. The inverter access code required for this menu area can be requested in the Fronius Solar.SOS portal.

Requesting inverter codes in Solar.SOS:

- 1** Go to [solar-sos.fronius.com](https://solar-sos.fronius.com) in a browser
- 2** Log in with your Fronius account
- 3** Click on the drop-down menu at the top right 
- 4** Select the menu item **Show inverter codes**

- ✓ *A contract page appears on which the request for the access code to change the grid parameters for Fronius inverters is located*

- 5 Accept the terms and conditions of use by checking **Yes, I have read and agree to the terms of use** and click **Confirm & Save**
- 6 After that, the codes can be retrieved from the drop-down menu at the top right under **Show inverter codes**

**⚠ CAUTION!**

**Risk due to unauthorized access.**

Incorrectly set parameters can negatively influence the public grid and/or the inverter grid power feed operation, and lead to a loss of conformity with the standard.

- ▶ The parameters may only be adjusted by installers/service technicians from authorized specialist companies.
- ▶ Do not give the access code to third parties and/or unauthorized persons.

**Adjusting parameters with the Fronius Solar.start app**

The "Fronius Solar.start" app is needed for registration. Depending on the end device, the app is available on the respective platform.



- 1 Start the installation in the app.
- 2 Select the product to which the connection should be established.
- 3 Open the access point by touching the sensor once → Communication LED: flashes blue.
- 4 Select the **"Technician"** user in the **"User menu"** and enter and confirm the password for the **"Technician"** user.
- 5 Call up the **"Safety and grid regulations"** → **"Country setup"** menu area.
- 6 Enter the requested access code (see chapter **Requesting inverter codes in Solar.SOS** on page 4) in the input field **"Access code country setup"** and click the button **"Activate"**.
- 7 Adjust the parameters in the individual menu areas taking into account the nationally applicable standards and/or the specifications of the utility.

## Adjusting parameters with the browser

### WLAN:

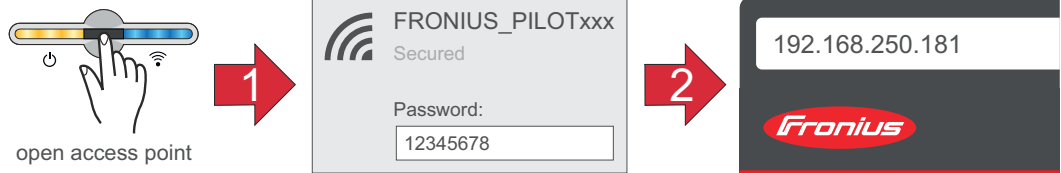

- 1 Open the access point by touching the sensor once → Communication LED: flashes blue.
- 2 Establish the connection to the inverter in the network settings (the inverter is displayed with the name "FRONIUS\_PILOT" and the serial number of the device).
- 3 Password: enter 12345678 and confirm.  
**IMPORTANT!**  
To enter the password on a Windows 10 operating system, the link "Connect using a security key instead" must first be activated to establish a connection with the password: 12345678.
- 4 In the browser address bar, enter and confirm the IP address 192.168.250.181.
- 5 Select the "Technician" user in the "User menu" and enter and confirm the password for the "Technician" user.
- 6 Call up the "**Safety and grid regulations**" → "**Country setup**" menu area.
- 7 Enter the requested access code (see chapter [Requesting inverter codes in Solar.SOS](#) on page 4) in the input field "**Access code country setup**" and click the button "**Activate**".
- 8 Adjust the parameters in the individual menu areas taking into account the nationally applicable standards and/or the specifications of the utility.

### Ethernet:

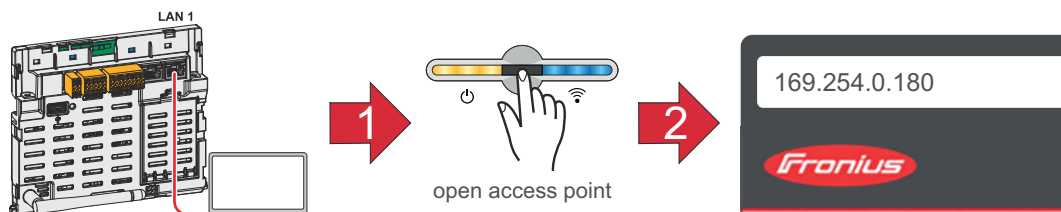

- 1 Establish a connection to the inverter (LAN1) with a network cable (CAT5 STP or higher).
- 2 Open the access point by touching the sensor once → Communication LED: flashes blue.
- 3 In the browser address bar, enter and confirm IP address 169.254.0.180.
- 4 Select the "**Technician**" user in the "**User menu**" and enter and confirm the password for the "**Technician**" user.
- 5 Call up the "**Safety and grid regulations**" → "**Country setup**" menu area.
- 6 Enter the requested access code (see chapter [Requesting inverter codes in Solar.SOS](#) on page 4) in the input field "**Access code country setup**" and click the button "**Activate**".
- 7 Adjust the parameters in the individual menu areas taking into account the nationally applicable standards and/or the specifications of the utility.

# Country setup





# Country setup selection

---

## Country setup selection

Predefined setups can be selected in the "**Country setup selection**" menu. The selected country setup for the respective country contains preset parameters according to the nationally applicable standards and requirements. Depending on local grid conditions and the specifications of the utility, adjustments to the selected country setup may be necessary.

Parameter	Description
"Country / Region"	Selecting the respective country or region limits/ displays the available country setups for the inverter.
"Country setup"	Displays the available setups per country/region. A setup is a device configuration predefined by Fronius. The selection of the country setup must be made in consideration of the applicable standards or in coordination with the grid operator.
"Rated Frequency (Hz)"	The rated frequency is predetermined by the country setup selection. Changing this parameter affects the stable operation of the inverter and is therefore only permitted in consultation with Fronius.
"Rated Voltage (V)"	The rated voltage is predetermined by the choice of the country setup. Changing this parameter affects the stable operation of the inverter and is therefore only permitted in consultation with Fronius.

# General

## Startup and Reconnection

These parameters can be used to set the grid monitoring times before the inverter is switched on.

For the set time, both the mains voltage and the mains frequency must be within the permissible range before connection is allowed.

- The permissible range for the mains voltage is defined in the menu area "Grid and system protection" → "Voltage" → "Startup and reconnection" (see chapter [Voltage](#)).
- The permissible range for the mains frequency is defined in the menu area "Grid and system protection " → " Frequency " → " Startup and reconnection" (see chapter [Frequency](#)).

Parameter	Range of values	Description
"Grid Monitoring Time Startup"	1 - 900 [s]	Grid monitoring time before the inverter is switched on during a normal start-up process in seconds (e.g., at sunrise).

Parameter	Range of values	Description
"Grid Monitoring Time Reconnection"	1 - 900 [s]	Grid monitoring time before the inverter is switched back on after a grid fault (see table "Grid faults") in seconds (e.g., if a fault occurs in the AC grid during the day which causes the inverter to shut down).

The following errors are defined by the inverter as grid errors for this functionality:

Name	Description	"StateCode" name	"StateCode" number
"Overvoltage"	Mains voltage exceeds an overvoltage limit ("Inner, Middle, or Outer Limit Overvoltage").	"AC voltage too high"	1114
"Undervoltage"	Mains voltage falls below an undervoltage limit ("Inner, Middle or Outer Limit Undervoltage").	"AC voltage too low"	1119
"Overfrequency"	Mains frequency exceeds an overfrequency limit ("Inner, Outer or Alternative Limit Overfrequency").	"AC frequency too high"	1035
"Underfrequency"	Mains frequency falls below an underfrequency limit ("Inner, Outer or Alternative Limit Underfrequency").	"AC frequency too low"	1037
"Fast Overvoltage Disconnect"	Triggering of the fast surge protection (> 135%).	"Grid voltage too high (fast overvoltage cut-out)"	1115, 1116

Name	Description	"StateCode" name	"StateCode" number
"Long Time Average Overvoltage Limit"	Mains voltage exceeds the long-term overvoltage limit ("Long Time Average Limit").	"Long-term mains voltage limit exceeded"	1117
"Unintentional Islanding Detection."	Unintentional islanding was detected.	"Islanding detected"	1004

## Ramp rates

Ramp rates limit the maximum rate of change of effective power in special situations. Rising ramps ("**Ramp-Up**") limit the increase in effective power at the inverter AC output. Falling ramps ("**Ramp-Down**") limit the reduction of effective power at the AC output of the inverter.

Note that the lowest rate of change is applied if multiple rates of change have been entered. An "**Irradiation Ramp**" can thus be rendered ineffective by, for example, a lower "**Startup Ramp**" or another function affecting the rate of change (e.g., P(U) or P(F)).

### "Ramp-Up at Startup and Reconnection"

When connecting the inverter, the maximum rate of change of the effective power can be limited by a rising ramp with a defined gradient. As soon as the effective power increase is influenced due to the available PV power or another control, the ramp is terminated.

Parameter	Range of values	Description
"Ramp-Up at Startup and Reconnection"	On	The effective power is limited at the " <b>Startup</b> " or a " <b>Reconnection</b> " with a rate of change of " <b>Ramp-Up at Startup and Reconnection Rate</b> ".
	Off	The function is deactivated.
"Ramp-Up at Startup and Reconnection Rate."	0.001 - 100 [%/s]	Permitted rate of change of the effective power at " <b>Startup</b> " or " <b>Reconnection</b> ".

### "Ramp-Up/Down Irradiation"

The "**Irradiation Ramp**" is a permanent limitation of the rate of change for the effective power. If the PV power changes rapidly due to passing clouds, the rate of change of the inverter output power is limited with the "**Ramp-Up Irradiation Rate**" or the "**Ramp-Down Irradiation Rate**".

Parameter	Range of values	Description
"Ramp-Up Irradiation"	On	The effective power increase is limited with a rate of change of " <b>Ramp-Up Irradiation Rate</b> ".
	Off	The function is deactivated.
"Ramp-Up Irradiation Rate"	0.001 - 200 [%/s]	Permitted rate of change during power increase.

Parameter	Range of values	Description
<b>"Ramp-Down Irradiation"</b>  <b>Note:</b> This function only has an effect on inverters with storage.	On	The effective power reduction is limited with a rate of change of <b>"Ramp-Down Irradiation Rate"</b> .
	Off	The function is deactivated.
<b>"Ramp-Down Irradiation Rate"</b>	0.001 - 200 [%/s]	Permitted rate of change of effective power.

**Example:** Effective power limitation by **"Irradiation-Ramp-Up/Down"**, which was caused by a change in the available PV power.

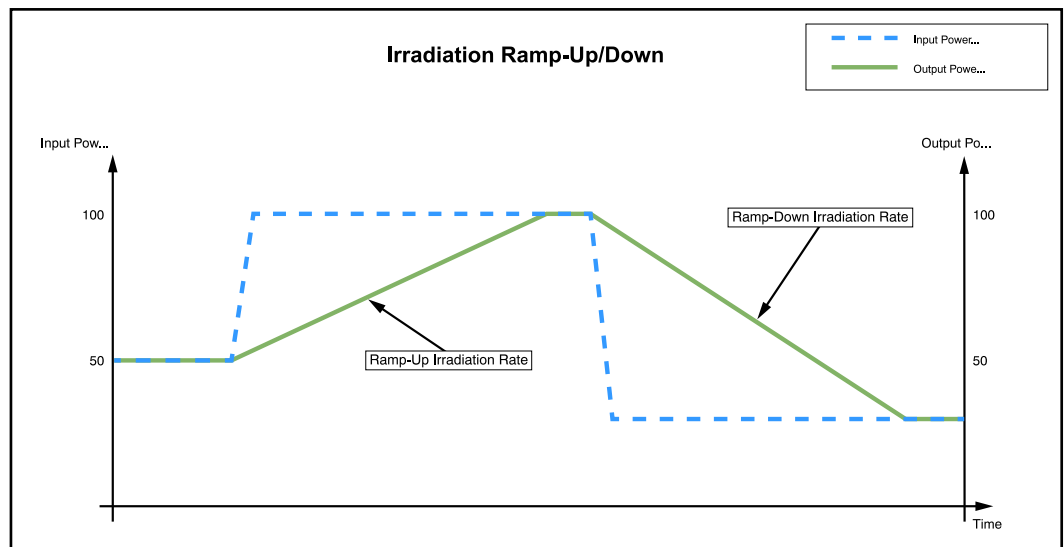

### "Ramp-Up/Down Communication"

This is a limitation of the effective power rate of change when changing external specifications for effective power. These can be, for example, power limitations via I/Os or Modbus commands. If smaller rates of change are specified via Modbus command, these are applied. Larger rates are limited by the parameter **"Ramp-Up Communication Rate"** or **"Ramp-Down Communication Rate"**.

Parameter	Range of values	Description
<b>"Ramp-Up Communication"</b>	On	The limitation of the rate of change (corresponding to <b>"Ramp-Up Communication Rate"</b> ) in case of effective power increase due to an external specification is activated.
	Off	The function is deactivated.
<b>"Ramp-Up Communication Rate"</b>	0.001 - 100 [%/s]	Permitted rate of change during power increase.
<b>"Ramp-Down Communication"</b>	On	The limitation of the rate of change (corresponding to <b>"Ramp-Down Communication Rate"</b> ) in the event of effective power reduction due to an external specification is activated.
	Off	The function is deactivated.

<b>Parameter</b>	<b>Range of values</b>	<b>Description</b>
<b>"Ramp-Down Communication Rate"</b>	0.001 - 100 [%/s]	Permitted rate of change for power reduction.

# Safety

## Unintentional islanding detection

### Unintentional islanding

In the event of a grid failure or disconnection of a small part of the grid from the higher-level utility grid, it is possible under special conditions for local loads and inverters to establish unintentional islanding (stand-alone operation). If the generation and load (of both active and reactive power) are balanced, the AC voltage and frequency can remain within the allowable limits. In this case, the inverter (without additional islanding detection) will continue grid power feed operation, will not automatically shut down, and will supply power to the local loads. This is an unwanted condition. To prevent these situations, active or passive islanding detection methods can be used.

### Active islanding detection

The inverter's active islanding detection function detects unwanted islanding situations, the inverter stops grid power feed operation, and disconnects from the AC grid at all poles.

The detection process is carried out using a mains frequency shift method (Active Frequency Drift): In the event of short-term mains frequency changes, the inverter feeds in an alternating current with a changed frequency (frequency shift). In the event of an interruption to the grid, the AC voltage will also change its frequency. There is a co-feedback effect, whereby the frequency is shifted so much that it exceeds or falls below the permissible limits. This causes the inverter to stop grid power feed operation.

In the case of three-phase inverters, the method is also able to detect islanding on any individual phases. This function is an active islanding detection method, since the inverter specifically changes its feed-in behavior during the detection process.

Parameter	Range of values	Standard value	Description
"Unintentional Islanding Detection."	On		Active islanding detection is activated.
	Off	Off	Active islanding detection is deactivated.
"Quality Factor"	0.1 - 10.0	1.0	The higher this value, the stronger/more aggressive the frequency shift of the islanding detection. Higher values therefore result in shorter islanding detection times. However, values that are too high can also have a negative effect on the voltage quality.

In contrast, there are passive methods that detect islanding based only on the measurement of AC network variables. This group includes, for example, "**Rate of Change of Frequency (RoCoF) Protection**".

## Isolation monitoring

### Isolation monitoring ("Iso Monitoring")

The inverter performs an isolation measurement at the DC terminals of the PV generator before each connection (at least once a day). Isolation monitoring

must be activated for both the isolation warning and the isolation error.

### Isolation Warning

The measured value of the isolation monitoring is used for an isolation warning. Status code 1083 is displayed if the measured value falls below an adjustable limit value.

### Isolation Error

The measured value of the isolation monitoring is also used for isolation error monitoring. If the measured isolation value is below the limit value "**Isolation Error Threshold**", grid power feed operation is prevented and status code 1082 is displayed.

### IMPORTANT!

For the "**Isolation Monitoring**" function, the parameters in the two menu sections described must be configured accordingly.

- 1** The parameters below in the menu item "**Safety and grid regulations**" → "**Country setup**" → "**Safety**" → "**Isolation monitoring**" are used to configure the parameters for the isolation measurement:

Parameter	Range of values	Description
"Iso Monitoring Mode"	On	The function is activated.
	Off	The function is deactivated.
	Off (with Warning)	Isolation monitoring is deactivated and status code 1189 is permanently displayed on the user interface of the inverter.
"Isolation Error Threshold"	0.1 - 10 MOhm	If the measured isolation value is lower than this value, grid power feed operation is prevented (if isolation monitoring is activated) and status code 1182 is displayed on the user interface of the inverter.

- 2** The parameters below in the menu item "**Device configuration**" → "**Inverter**" → "**Iso warning**" are used to configure the parameters for the isolation warning:

Parameter	Range of values	Description
"Iso Warning"	On	The isolation warning is activated. If the isolation warning threshold is undershot, a warning occurs but not a shutdown.
	Off	The function is deactivated.
"Isolation measurement mode"	Precise	Isolation monitoring is performed with the highest accuracy and the measured insulation resistance is displayed on the user interface of the inverter.
	Quick	Isolation monitoring is performed with lower accuracy, which shortens the duration of the isolation measurement and the isolation value is not displayed.

Parameter	Range of values	Description
"Isolation Warning Threshold"	0.1 - 10 MOhm	If this value is undershot, status code 1183 is displayed on the user interface of the inverter.

## DC arc fault protection

These parameters can be used to set the behavior of the arc detection at the DC terminals of the inverter. The DC arc fault protection function protects against arc faults and contact faults. Any faults that occur in the current and voltage curve are constantly evaluated and the current circuit is switched off if a contact fault is detected. This prevents overheating on defective contacts and possible fires.

Parameter	Range of values	Description
"Arc Fault Detection (AFD)"		For activating and deactivating the arc fault detection. The parameters "Arc logging" and " <b>Automatic reconnects</b> " are only considered with activated " <b>Arc Fault Detection (AFD)</b> ".
	Off	Arcs are not detected.
	Off (with Warning)	Arcs are not detected and status code 1184 is permanently displayed on the user interface of the inverter.
	On	The arc detection is active.
"Arc-Fault Circuit Interrupter (CI)"		Describes the behavior in the event of a detected arc and simultaneously activates/deactivates the integrated self-test.
	Off	The detection of an arc does not cause the inverter to shut down and is not displayed on the user interface of the inverter.
	Off (with Warning)	The detection of an arc does not cause the inverter to shut down. The status code 1185 is permanently displayed on the user interface of the inverter.
	On	If an arc is detected, the inverter interrupts grid power feed operation and the status code 1006 is displayed on the user interface of the inverter. Depending on the configuration of the parameter " <b>Automatic Reconnects</b> ", the inverter will attempt to restart grid power feed operation after 5 minutes. Furthermore, an integrated self-test is active, which is executed at regular intervals. If this fails, the inverter stops grid power feed operation and status code 1009 is displayed.



Parameter	Range of values	Description
<b>"Automatic Re-connects"</b>		If more arcs have been detected within 24 hours than are defined in <b>"Automatic Re-connects"</b> , the inverter will not make any further attempt to start grid power feed operation. The status code 1006 is displayed on the user interface of the inverter after each detection and must be acknowledged manually.
	Unlimited	The 24 hour counter is deactivated. The inverter restarts grid power feed operation 5 minutes after each arc detected.
	0 - No Reconnection	After an arc has been detected, no further attempt is made to start grid power feed operation and status code 1173 is displayed on the user interface of the inverter.
	1 - 4	After a shutdown by an arc, 1, 2, 3, or 4 attempts are made within 24 hours to restart grid power feed operation. After this number of attempts, no further attempt is made to start grid power feed operation and status code 1173 is displayed on the user interface of the inverter.
<b>"Arc Logging"</b>		Enables or disables the recording of arc signatures. The data is uploaded to the cloud and used to continuously improve the interference immunity and fault tolerance of arc detection.
	Off	Arc signatures are not recorded.
	On	Arc signatures are recorded, uploaded to the cloud, and used to continuously improve the interference immunity and fault tolerance of arc detection.
<b>"Automatic Signal Recording"</b>		Activates or deactivates recording of the inverter's signal characteristics to continuously improve arc detection.
	Off	Recording is deactivated.
	On	Recording is activated. With a probability in accordance with the <b>"Recording Probability"</b> parameter, data is recorded and uploaded to the cloud every 10 minutes.

Parameter	Range of values	Description
"Recording Probability"		If " <b>Automatic Signal Recording (ASR)</b> " is activated, the frequency for a recording can be set here.
	0	No signal characteristics are recorded.
	0.0 - 1.0	Every 10 minutes, data is uploaded to the cloud with a frequency in accordance with the "Recording Probability".  <b>Example:</b> With a setting value of 0.1, data is uploaded on average every 100 minutes.
	1	Data is recorded every 10 minutes.

## RCMU

The inverter is equipped with a universal current-sensitive residual current monitoring unit (RCMU) in accordance with IEC 62109-2. This unit monitors residual currents from the PV module to the AC output of the inverter and disconnects the inverter from the grid in the event of unauthorized residual current.

Parameter	Range of values	Description
"RCMU"	Off	The protective function is deactivated.
	Off (with Warning)	The protective function is deactivated. The status code 1188 is permanently displayed on the user interface of the inverter.
	On	The protective function is activated.

Parameter	Range of values	Description
"Automatic Reconnects"		If more fault currents have been detected within 24 hours than are defined in "Automatic Reconnects", the inverter will not make any further attempt to start grid power feed operation. The status code 1076 is displayed on the user interface of the inverter and must be acknowledged manually.
	0	No fault current above 300 mA is tolerated. After each detected fault current, grid power feed operation is interrupted and the status code must be acknowledged manually on the user interface of the inverter.
	1 - 4	After a shutdown due to a fault current exceeding 300 mA, 1, 2, 3, or 4 attempts are made within 24 hours to restart grid power feed operation. After this number of attempts, no further attempt is made to start grid power feed operation and the status code must be acknowledged manually on the user interface of the inverter.
	Unlimited	The 24 hour counter is deactivated. The inverter restarts grid power feed operation after each detected fault current above 300 mA.

### DC shutdown communication

Devices for shutdown within the DC generator (e.g., in or on the module or within a string) can be controlled by the inverter. The condition for this is compatibility, especially with the communication of the inverter.

Parameter	Range of values	Description
"Powerline Communication"		Activates and deactivates DC powerline communication (PLC) on the inverter.
	PLC Off	DC powerline communication is deactivated on the inverter. There are no shutdown devices installed in the PV system, or if shutdown devices are installed in the PV system that are waiting for an enable signal, then this signal must come from another device (transmitter) (otherwise the system will not function).
	SunSpec PLC	The inverter communicates with DC powerline communication according to the " <b>SunSpec Rapid Shutdown Standard</b> ". Compatible shutdown devices must be used for the correct functioning of the PV system.

# Interface protection

## Voltage

This chapter deals with the protection settings for overvoltage and undervoltage. Mains voltage limits are defined for this purpose. These depend on the country setup and can be adjusted as described below.

Each mains voltage limit is defined by:

- an undervoltage with associated protection time, or
- an overvoltage with associated protection time.

The protection time describes the duration for which the voltage may be outside the respective voltage limit value before the inverter switches off with an error message.

Three overvoltage and three undervoltage limit values can be used. The **"Inner Limits"** ( $U<$  for undervoltage;  $U>$  for overvoltage) refer to those limit values which are closer to the nominal voltage. The **"Middle Limits"** ( $U<$  for undervoltage;  $U>$  for overvoltage) have a greater distance to the nominal voltage. The greatest distance between the nominal voltage and the limit value is for the **"Outer Limits"** ( $U\ll$  for undervoltage;  $U\gg$  for overvoltage).

For expedient use of the **"Inner Limits"** and **"Outer Limits"**, the respective **"Inner Limit"** must be linked to a greater time than the **"Outer Limit"**. If the **"Middle Limits"** are also used, their time must be set between **"Inner Limit"** and **"Outer Limit"**; see example in the diagram.

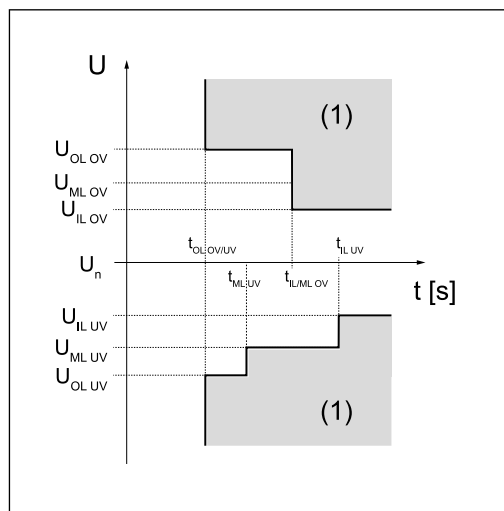

- IL **"Inner limit"** - inner limit value
- ML **"Middle Limit"** - middle limit value
- OL **"Outer limit"** - outer limit value
- (1) Trip range
- OV Overvoltage
- UV Undervoltage
- $t_x$  Protection time

Graphic illustrating the limits

These voltage limit values are not active in backup power mode. Under **"Device configuration"** → **"Inverter"** → **"Backup power"**, the voltage limits that apply in backup power mode can be configured.

### "Inner Limits"

Parameter	Description
<b>"Undervoltage <math>U&lt;</math>"</b>	Setting value for undervoltage protection $U<$ in [V]
<b>"Undervoltage Time <math>U&lt;</math>"</b>	Setting value of time for undervoltage protection $U<$ in [s]
<b>"Overvoltage <math>U&gt;</math>"</b>	Setting value for surge protection $U>$ in [V]
<b>"Overvoltage Time <math>U&gt;</math>"</b>	Setting value of time for surge protection $U>$ in [s]

### "Middle Limits"

Parameter	Description
"Voltage Middle Limits"	Activate/deactivate the middle voltage limit values "On" / "Off"
"Undervoltage U<"	Setting value for undervoltage protection U< in [V]
"Undervoltage Time U<"	Setting value of time for undervoltage protection U< in [s]
"Overvoltage U>"	Setting value for surge protection U> in [V]
"Overvoltage Time U>"	Setting value of time for surge protection U> in [s]

---

### "Outer Limits"

Parameter	Description
"Voltage Outer Limits"	Activate/deactivate the outer voltage limit values "On" / "Off"
"Undervoltage U<<"	Setting value for undervoltage protection U<< in [V]
"Undervoltage Time U<<"	Setting value of time for undervoltage protection U<< in [s]
"Overvoltage U>>"	Setting value for surge protection U>> in [V]
"Overvoltage Time U>>"	Setting value of time for surge protection U>> in [s]

---

### "Long Time Average Limit"

This function calculates a moving average voltage value over the set time and compares it with the set overvoltage protection value. If the overvoltage protection value is exceeded, a disconnect occurs.

Parameter	Description
"Long Time Average Limit"	Activate/deactivate the voltage average limit value "On" / "Off"
"Overvoltage Averaging Time U>"	Time period over which the average value is calculated in [s]. (If 0 s is set, the check is not active)
"Overvoltage U>"	Setting value of the surge protection with average value formation U> in [V]

---

### "Fast Overvoltage Disconnect"

Fast overvoltage disconnect for voltage spikes that can respond within one period.

Parameter	Description
"Fast Overvoltage Disconnect"	Activate/deactivate fast RMS overvoltage disconnect (exceeding 135 % of rated voltage) "On" / "Off"
"Fast Overvoltage Disconnect Time"	Setting value of time for fast surge protection (peak value exceeded by 35 %) in [s]. This disconnect can be configured in the time range of microseconds.

---

### "Startup and Reconnection"

Before the inverter is allowed to connect, the connection conditions for voltage

and frequency must be fulfilled for a certain time.

A distinction is made between:

- **"Startup"**: switching on the inverter during a normal startup process (e.g., at sunrise) and
- **"Reconnection"**: the reconnection of the inverter after a grid fault (see table **"Grid faults"**) (e.g., if a fault occurs in the AC grid during the day which causes the inverter to disconnect).

Which limit values are used when checking the connection conditions depends on whether a grid fault has occurred and which **"Mode"** is defined. The **"Mode"** only influences the limit values and not the monitoring time. The monitoring time is determined by the parameters described in **"General"** / **"Startup and Reconnection"**. The monitoring time used depends on whether a **"Startup"** or **"Reconnection"** is taking place, and applies equally to frequency and voltage limits. After the grid monitoring has expired, the previously mentioned **"Interface Protection"** values are active. In backup power mode these **"Startup and Reconnection"** parameters are not active.

Parameter	Description
"Mode"	<p><b>The following modes are available:</b></p> <ul style="list-style-type: none"> <li>- <b>"Startup Values are used for Startup / Reconnection Values are used for Reconnection"</b>: In a normal startup process, the startup values are used as connection conditions. When reconnecting after a grid fault, the reconnection values are used as connection conditions.</li> <li>- <b>"Startup Values are used for Startup and Reconnection"</b>: Regardless of the type of connection, the startup values are always used as connection conditions.</li> </ul>
"Reconnection Minimum Voltage"	Lower value of the voltage for reconnection in [V]
"Reconnection Maximum Voltage"	Upper value of the voltage for reconnection in [V]
"Startup Minimum Voltage"	Lower value of the voltage for the normal start process in [V]
"Startup Maximum Voltage"	Upper value of the voltage for the normal start process in [V]
The following errors are defined by the inverter as grid errors for this functionality:	

Name	Description	"StateCode" name	"StateCode" number
"Overvoltage"	Mains voltage exceeds an overvoltage limit ( <b>"Inner, Middle, or Outer Limit Overvoltage"</b> ).	"AC voltage too high"	1114
"Undervoltage"	Mains voltage falls below an undervoltage limit ( <b>"Inner, Middle or Outer Limit Undervoltage"</b> ).	"AC voltage too low"	1119

Name	Description	"StateCode" name	"StateCode" number
"Overfrequency"	Mains frequency exceeds an overfrequency limit ("Inner, Outer or Alternative Limit Overfrequency").	"AC frequency too high"	1035
"Underfrequency"	Mains frequency falls below an underfrequency limit ("Inner, Outer or Alternative Limit Underfrequency").	"AC frequency too low"	1037
"Fast Overvoltage Disconnect"	Triggering of the fast surge protection (> 135%).	"Grid voltage too high (fast overvoltage cut-out)"	1115, 1116
"Long Time Average Overvoltage Limit"	Mains voltage exceeds the long-term overvoltage limit ("Long Time Average Limit").	"Long-term mains voltage limit exceeded"	1117
"Unintentional Islanding Detection."	Unintentional islanding was detected.	"Islanding detected"	1004

## Frequency

This chapter deals with the protection settings for overfrequencies and underfrequencies. Mains frequency limit values are defined for this purpose. These depend on the country setup and can be adjusted as described below.

Each frequency limit value is defined by:

- an underfrequency with associated protection time, or
- an overfrequency with associated protection time.

The protection time describes the duration for which the frequency may be outside the respective frequency limit value before the inverter switches off with an error message. Two overfrequency and two underfrequency limit values can be used. The "**Inner Limits**" ( $f <$  for underfrequency;  $f >$  for overfrequency) are those limit values which are closer to the rated frequency than the "**Outer Limits**" ( $f <<$  for underfrequency;  $f >>$  for overfrequency). For the sensible use of both ranges, the respective "**Inner Limit**" must be linked to a larger time than the "**Outer Limit**".

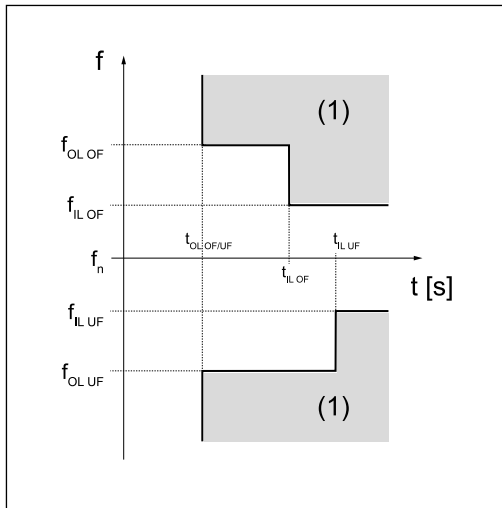

IL     **"Inner limit"** - inner limit value  
 OL     **"Outer limit"** - outer limit value  
 (1)    Trip range  
 OF     Overfrequency  
 UF     Underfrequency

Graphic illustrating the limits

In backup power mode, the inverter itself determines the frequency and the frequency limits are therefore not active.

### "Inner Limits"

Parameter	Description
"Underfrequency f<"	Setting value of underfrequency protection f< in [Hz]
"Underfrequency Time f<"	Setting value of time for underfrequency protection f< in [s]
"Overfrequency f>"	Setting value of overfrequency protection f> in [Hz]
"Overfrequency Time f>"	Setting value of time for overfrequency protection f> in [s]

### "Outer Limits"

Parameter	Description
"Frequency Outer Limits"	Activate/deactivate the outer frequency limits "On"/"Off"
"Underfrequency f<<"	Setting value of underfrequency protection f<< in [Hz]
"Underfrequency Time f<<"	Setting value of time for underfrequency protection f<< in [s]
"Overfrequency f>>"	Setting value of overfrequency protection f>> in [Hz]
"Overfrequency Time f>>"	Setting value of time for overfrequency protection f>> in [s]

### "Alternative Limits"

For the inner frequency limit values there is an additional second parameter set, which is only relevant for Italy. In order to activate this second parameter set, the alternative frequency limit value must be set to **"On"** on the user interface of the inverter and activated/deactivated via an external signal as follows:

- **Activate:** <http://<IP>/status/SetSignaleEsterno>
- **Deactivate:** <http://<IP>/status/ClearSignaleEsterno>



Each time the inverter is restarted, the **"Frequency Alternative Limit"** does not have to be set to **"On"** again, but the external signal to activate it must be sent again. If it is not sent, the inner frequency limit value is used.

Parameter	Description
<b>"Frequency Alternative Limits"</b>	Activate/deactivate alternative frequency limit values <b>"On"/"Off"</b>
<b>"Underfrequency f&lt;"</b>	Setting value of alternative underfrequency protection f< in [Hz]
<b>"Underfrequency Time f&lt;"</b>	Setting value of time for the alternative underfrequency protection f< in [s]
<b>"Overfrequency f&gt;"</b>	Setting value of alternative overfrequency protection f> in [Hz]
<b>"Overfrequency Time f&gt;"</b>	Setting value of time for the alternative overfrequency protection f> in [s]

### **"Startup and Reconnection"**

Before the inverter is allowed to connect, the connection conditions for voltage and frequency must be fulfilled for a certain time.

A distinction is made between:

- **"Startup"**: switching on the inverter during a normal startup process (e.g., at sunrise) and
- **"Reconnection"**: the reconnection of the inverter after a grid fault (see table **"Grid faults"**) (e.g., if a fault occurs in the AC grid during the day which causes the inverter to disconnect).

Which limit values are used when checking the connection conditions depends on whether a grid fault has occurred and which **"Mode"** is defined. The **"Mode"** only influences the limit values and not the monitoring time. The monitoring time is determined by the parameters described in **"General"** / **"Startup and Reconnection"**. The monitoring time used depends on whether a **"Startup"** or **"Reconnection"** is taking place, and applies equally to frequency and voltage limits. After the grid monitoring has expired, the previously mentioned **"Interface Protection"** values are active. In backup power mode these **"Startup and Reconnection"** parameters are not active.

Parameter	Description
<b>"Mode"</b>	<p><b>The following modes are available:</b></p> <ul style="list-style-type: none"> <li>- <b>"Startup Values are used for Startup / Reconnection Values are used for Reconnection"</b>: In a normal startup process, the startup values are used as connection conditions. When reconnecting after a grid fault, the reconnection values are used as connection conditions.</li> <li>- <b>"Startup Values are used for Startup and Reconnection"</b>: Regardless of the type of connection, the startup values are always used as connection conditions.</li> <li>- <b>"Startup Values are used for Reconnection"</b>: When reconnecting after a grid fault, the startup values are used as reconnection conditions. In a normal start-up procedure, the <b>"Frequency Inner Limits"</b> f&lt; and f&gt; are used as connection conditions.</li> </ul>

Parameter	Description
"Reconnection Minimum Frequency"	Lower value of the mains frequency for reconnection in [Hz]
"Reconnection Maximum Frequency"	Upper value of the mains frequency for reconnection in [Hz]
"Startup Minimum Frequency"	Lower value of the mains frequency for the normal start process in [Hz]
"Startup Maximum Frequency"	Upper value of the mains frequency for the normal start process in [Hz]
The following errors are defined by the inverter as grid errors for this functionality:	

Name	Description	"StateCode" name	"StateCode" number
"Overvoltage"	Mains voltage exceeds an overvoltage limit ("Inner, Middle, or Outer Limit Overvoltage").	"AC voltage too high"	1114
"Undervoltage"	Mains voltage falls below an undervoltage limit ("Inner, Middle or Outer Limit Undervoltage").	"AC voltage too low"	1119
"Overfrequency"	Mains frequency exceeds an overfrequency limit ("Inner, Outer or Alternative Limit Overfrequency").	"AC frequency too high"	1035
"Underfrequency"	Mains frequency falls below an underfrequency limit ("Inner, Outer or Alternative Limit Underfrequency").	"AC frequency too low"	1037
"Fast Overvoltage Disconnect"	Triggering of the fast surge protection (> 135%).	"Grid voltage too high (fast overvoltage cut-out)"	1115, 1116
"Long Time Average Overvoltage Limit"	Mains voltage exceeds the long-term overvoltage limit ("Long Time Average Limit").	"Long-term mains voltage limit exceeded"	1117
"Unintentional Islanding Detection."	Unintentional islanding was detected.	"Islanding detected"	1004

#### "Rate of Change of Frequency (RoCoF) Protection"

This function allows the RoCoF (Rate of Change of Frequency) -detection and -switch-off to be activated and adjusted. In the event of frequency changes that are above a set value and last longer than the set time, the inverter is shut down.

RoCoF detection can be used as a passive stand-alone operation detection method.

Parameter	Description
"Rate of Change of Frequency (RoCoF) Protection."	Activate and deactivate the RoCoF protection. "On" / "Off"
"ROCOF Limit"	Setting value of the frequency change protection in [Hz/s]
"RoCoF Time"	Setting value of time for the RoCoF protection in [s]

## DC injection

DC injection means the injection of an AC current into the public grid that is unintentionally contaminated with a DC component. This DC component causes a shift of the pure AC current on the Y-axis (offset).

Due to the way the inverter works, no DC injection takes place in normal operation. However, in order to be protected against faults or inaccuracies, many connection rules require monitoring of the DC injection and shutdown if limit values are exceeded.

Inner and outer limits can be defined for the limit values. Inner limits have tighter limits and longer protection times by default, outer limits have broader limits and shorter protection times, so that shutdown occurs more quickly with higher DC components. For both limit values there is a protection time which defines the maximum overshoot duration.

### "Inner Limit"

Parameter	Range of values	Description
"Mode"	Off	Monitoring of the inner limit is deactivated.
	Absolute	DC component monitoring with an absolute current limit in [A].
	Relative	DC component monitoring with a relative current limit expressed as a percentage [%] of the nominal current of the inverter.
"DC Current Absolute Value"	0.0 A - 10.0 A	Absolute DC current limit in [A] - If the DC component of the injected AC current exceeds this limit for the duration defined with " <b>DC Injection Time</b> ", grid power feed operation is interrupted with status code 1052. This limit only applies to the " <b>Absolute</b> " mode.
"DC Current Relative Value"	0.0 % - 10.0 %	Relative DC current limit expressed as a percentage of the nominal current of the inverter - If the relative DC component of the injected AC current exceeds this limit for the duration defined with " <b>DC Injection Time</b> ", grid power feed operation is interrupted with status code 1052. This limit only applies to the " <b>Relative</b> " mode.

Parameter	Range of values	Description
"DC Injection Time"	0.0 s - 10.0 s	Protection time for the inner limit - Shutdown occurs after the respective limit value has been exceeded for this time.

**"Outer Limit"**

Parameter	Range of values	Description
"Mode"	Off	Monitoring of the outer limit is deactivated.
	Absolute	DC component monitoring with an absolute current limit in [A].
	Relative	DC component monitoring with a relative current limit expressed as a percentage [%] of the nominal current of the inverter.
"DC Current Absolute Value"	0.0 A - 10.0 A	Absolute DC current limit in [A] - If the DC component of the injected AC current exceeds this limit for the duration defined with " <b>DC Injection Time</b> ", grid power feed operation is interrupted with status code 1052. This limit only applies to the " <b>Absolute</b> " mode.
"DC Current Relative Value"	0.0 % - 10.0 %	Relative DC current limit expressed as a percentage of the nominal current of the inverter - If the relative DC component of the injected AC current exceeds this limit for the duration defined with " <b>DC Injection Time</b> ", grid power feed operation is interrupted with status code 1052. This limit only applies to the " <b>Relative</b> " mode.
"DC Injection Time"	0.0 s - 10.0 s	Protection time for the outer limit - Shutdown occurs after the respective limit value has been exceeded for this time.

# Grid support functions

## Voltage fault ride through (VFRT)

In the event of faults in the grid, there is a risk of a large number of generation plants being shut down unintentionally and thus a risk of network collapse. Mains voltage disturbances (Voltage Fault, Gridvoltage-Disturbance) are short-term voltage dips or surges in the grid. These voltage changes go beyond the normal range of the operating voltage (e.g., nominal voltage +/- 10 %). However, the duration of the voltage changes is short, so that the normal operating voltage is reached again before the system is shut down (due to "**Interface Protection**"). Voltage fault ride through means that the inverter can ride through such a mains voltage fault without shutting down prematurely. If the shutdown conditions of the protection settings ("**Grid and system protection**" or "**Interface Protection**") are reached (time and value), the inverter always shuts down, thus terminating VFRT operation. The requirements for the exact behavior of the inverters during the fault depend on the respective grid connection rules. The following parameters determine this behavior.

### Classification into regions

The voltage fault detection of the inverter detects severe or rapid mains voltage fluctuations and classifies them into so-called regions according to the level of the fault voltage (voltage level during the fault). Each region is assigned a specific mains voltage value range. Three individual regions (R1, R2, R3) can be configured. Each individual region has an adjustable detection threshold and several parameters that determine the behavior of the inverter within that region. The detection limit is a relative voltage level and is specified as a percentage of the AC nominal voltage. A value above 100 % means that the associated region describes an overvoltage disturbance (High Voltage Ride Through, HVRT). A value less than 100 % means that the associated region describes an undervoltage fault (Low Voltage Ride Through, LVRT). Figure 1 shows an example of a typical arrangement of the three regions (shown here with horizontal bars) by selective choice of detection thresholds: R1 threshold 110 %, R2 threshold 90 %, R3 threshold 40 %. The voltage range between the limits of Region1 and Region2 (white bar) comprises the voltage range for normal operation (here: 90 to 110 % of the nominal voltage). Region 1 comprises overvoltage disturbances, Region 2 consists of slight undervoltage disturbances (from 90 to 40 %). Region 3 consists of severe undervoltage disturbances (below 40 %).

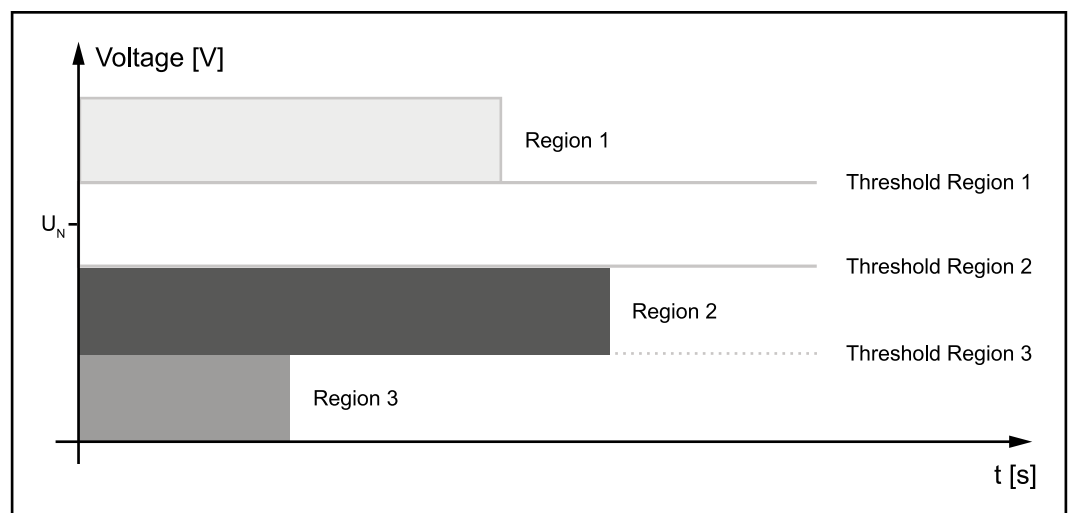

Division of the grid voltage range into three fault regions by selecting the detection thresholds.

### IMPORTANT!

The length of the bars represents trip times for overvoltage and undervoltage

detection of the **"Interface Protection"** function group. This has no significance for the VFRT functionality.

**Regions R1 to R3 must have descending values of detection thresholds:**

- The R1 threshold must be higher than the R2 threshold, and so on.
- The use of identical thresholds for multiple regions is prohibited.
- Using the threshold value 0 % is allowed.

**To deactivate a specific region, its threshold can be used:**

An HV region (R1) is deactivated by adjusting the threshold to 200 %. An unused LV region (usually R3) is deactivated by adjusting the threshold to 0 %.

**General VFRT settings**

The following setting values apply equally to all regions.

Parameter	Value range	Standard value	Description
"Mode"	On		VFRT function is active according to the set parameter values.
	Off	Off	If no special behavior is required during grid disturbances, the inverter will behave according to the default values in this table with this setting. Any parameter settings made are ignored.
"Reactive Current Limit for Overexcited Operation."	0 - 110 [% IacNominal]	100 %	Limitation of the reactive current during a mains voltage fault and overexcited operation - as a percentage of the nominal current $I_N$ . This parameter is only effective for the current inrush mode <b>"Active Asymmetric Current"</b> .
"Reactive Current Limit for Underexcited Operation."	0 - 110 [% IacNominal]	100 %	Limitation of the reactive current during a mains voltage fault and underexcited operation - as a percentage of the nominal current $I_N$ . This parameter is only effective for the current inrush mode <b>"Active Asymmetric Current"</b> .

Parameter	Value range	Standard value	Description
"Sudden Voltage Change Detection"	On		The detection of sudden voltage changes within the normal voltage range is active. So-called sudden voltage changes do not usually violate static voltage limits, but are indicators of network disturbances.
	Off	Off	No detection of sudden voltage changes within the normal voltage range.
"Insensitivity Range"	0 - 100 [% Uac 1s-Avg]	5 %	Limit value that must be exceeded by a sudden change in voltage (change in the positive sequence voltage or negative sequence voltage) for a mains voltage fault to be detected. Reference value for the calculation of this limit value is the moving average value of the mains voltage over 1 second (1s-Avg).
"Deactivation Time"	0 - 100 [s]	5 s	Time duration of grid fault handling for sudden voltage changes. After this time has elapsed, the grid fault handling is automatically terminated if no static voltage limits (see parameter " <b>Threshold Static</b> " under Region 1, 2, 3) have been violated.

### Region 1

These setting values define how the inverter behaves within Region 1. The choice of setting has no effect on regions 2 and 3.

Parameter	Value range	Standard value	Description
"Static Threshold"	0 - 200 [% UacNominal]	125 %	<p>Static voltage threshold (in % of nominal voltage) that must be exceeded or fallen below to activate VFRT Region 1 and its associated current inrush mode.</p> <ul style="list-style-type: none"><li>- &gt; 100 % ... Region 1 is used as the HVRT region.</li><li>- &lt; 100 % ... Region 1 is used as the LVRT region.</li></ul> <p>Setting condition: Threshold R1 &gt; Threshold R2 &gt; Threshold R3</p> <p>Default value 125 % means that the inverter is in normal current feed-in operation up to 125 % of the nominal voltage. VFRT becomes active above 125 % with the selected current inrush mode (default mode for Region 1: "<b>Zero Current</b>").</p>



Parameter	Value range	Standard value	Description
<b>"Static Detection Mode"</b>			Voltage system used for static threshold detection of VFRT Region 1. For three-phase devices, the minimum value (for LVRT regions) or the maximum value (for HVRT regions) from the individual voltages is used in each case.
	L-N Voltage	L-N Voltage	The phase-to-neutral (line-to-neutral) voltage system is used for static threshold detection of VFRT Region 1.
	L-L Voltage		The phase-to-phase (line-to-line) voltage system is used for static threshold detection of VFRT Region 1.
	L-L and L-N Voltage		Both voltage systems (line-to-neutral and line-to-line) are used for static threshold detection of VFRT Region 1.

Parameter	Value range	Standard value	Description
<b>"Current Calc Mode"</b>			Current inrush mode for Region 1. This parameter defines the type of current feed during a Region 1 voltage fault.
	Passive		The pre-fault behavior is maintained as far as possible during the fault.
	Zero Current	Zero Current	The alternating current is adjusted to zero. There is no effective or reactive power feed-in during the fault.
	Active Symmetric Current		A symmetrical reactive current (positive-sequence system reactive current) is fed into the grid. The additional reactive current value results from the <b>"k-factor Positive Sequence"</b> multiplied by the amount of the voltage dip. No active current is fed in.
	Active Asymmetric Current		An additional reactive current is fed into the grid. At the same time, active current is fed in (whereby the reactive current has priority). The additional reactive current value results from the k-factors multiplied by the voltage dip value. If the <b>"k-factor Negative Sequence"</b> is set to 0, the feed is symmetrical. Otherwise, asymmetrical faults are responded to with an asymmetrical current infeed.
<b>"k-factor Positive Sequence"</b>	0 - 10	2.0	Multiplication factor (k-factor) for the positive-sequence system reactive current in Region 1. Only applied with current inrush mode <b>"Active Symmetric Current"</b> and <b>"Active Asymmetric Current"</b> .

Parameter	Value range	Standard value	Description
"k-factor Negative Sequence"	0 - 10	2.0	Multiplication factor (k-factor) for the negative-sequence system reactive current in Region 1. Only applied with current inrush mode " <b>Active Asymmetric Current</b> ". If an asymmetrical feed is required, this is usually set to the same value as " <b>k-factor Positive Sequence</b> ". If a symmetrical supply is required, this is set to 0.

## Region 2

These setting values define how the inverter behaves within Region 2. The choice of setting has no effect on regions 1 and 3.

Parameter	Value range	Standard value	Description
"Static Threshold"	0 - 200 [% UacNominal]	40 %	<p>Static voltage threshold (in % of nominal voltage) that must be exceeded or fallen below to activate VFRT Region 2 and its associated current inrush mode.</p> <ul style="list-style-type: none"> <li>- &gt; 100 % ... Region 2 is used as the HVRT region.</li> <li>- &lt; 100 % ... Region 2 is used as the LVRT region.</li> </ul> <p>Setting condition: Threshold R1 &gt; Threshold R2 &gt; Threshold R3</p> <p>Default value 40 % means that the inverter is in normal current feed-in operation up to 40 % of the nominal voltage. VFRT becomes active above 40 % with the selected current inrush mode (default mode for Region 2: "<b>Zero Current</b>").</p>

Parameter	Value range	Standard value	Description
<b>"Static Detection Mode"</b>			Voltage system used for static threshold detection of VFRT Region 2. For three-phase devices, the minimum value (for LVRT regions) or the maximum value (for HVRT regions) from the individual voltages is used in each case.
	L-N Voltage	L-N Voltage	The phase-to-neutral (line-to-neutral) voltage system is used for static threshold detection of VFRT Region 2.
	L-L Voltage		The phase-to-phase (line-to-line) voltage system is used for static threshold detection of VFRT Region 2.
	L-L and L-N Voltage		Both voltage systems (line-to-neutral and line-to-line) are used for static threshold detection of VFRT Region 2.

Parameter	Value range	Standard value	Description
"Current Calc Mode"			Current inrush mode for Region 2. This parameter defines the type of current feed during a Region 2 voltage fault.
	Passive		The pre-fault active current and reactive current is maintained for as long as the fault persists.
	Zero Current	Zero Current	The alternating current is adjusted to zero. There is no effective or reactive power feed-in during the fault.
	Active Symmetric Current		A symmetrical reactive current (positive-sequence system reactive current) is fed into the grid. The additional reactive current value results from the " <b>k-factor Positive Sequence</b> " multiplied by the amount of the voltage dip. No active current is fed in.
	Active Asymmetric Current		An additional reactive current is fed into the grid. At the same time, active current is fed in (whereby the reactive current has priority). The additional reactive current value results from the k-factors multiplied by the voltage dip value. If the " <b>k-factor Negative Sequence</b> " is set to 0, the feed is symmetrical. Otherwise, asymmetrical faults are responded to with an asymmetrical current infeed.
"k-factor Positive Sequence"	0 - 10	2.0	Multiplication factor (k-factor) for the positive-sequence system reactive current in Region 2. Only applied with current inrush mode " <b>Active Symmetric Current</b> " and " <b>Active Asymmetric Current</b> ".

Parameter	Value range	Standard value	Description
"k-factor Negative Sequence"	0 - 10	2.0	Multiplication factor (k-factor) for the negative-sequence system reactive current in Region 2. Only applied with current inrush mode " <b>Active Asymmetric Current</b> ". If an asymmetrical feed is required, this is usually set to the same value as " <b>k-factor Positive Sequence</b> ". If a symmetrical supply is required, this is set to 0.

### Region 3

These setting values define how the inverter behaves within Region 3. The choice of setting has no effect on regions 1 and 2.

Parameter	Value range	Standard value	Description
"Static Threshold"	0 - 200 [% UacNominal]	0 %	<p>Static voltage threshold (in % of nominal voltage) that must be exceeded or fallen below to activate VFRT Region 3 and its associated current inrush mode.</p> <ul style="list-style-type: none"> <li>- &gt; 100 % ... Region 3 is used as the HVRT region.</li> <li>- &lt; 100 % ... Region 3 is used as the LVRT region.</li> </ul> <p>Setting condition: Threshold R1 &gt; Threshold R2 &gt; Threshold R3</p> <p>Default value 0 % means that Region 3 is disabled/inactive.</p>

Parameter	Value range	Standard value	Description
<b>"Static Detection Mode"</b>			Voltage system used for static threshold detection of VFRT Region 3. For three-phase devices, the minimum value (for LVRT regions) or the maximum value (for HVRT regions) from the individual voltages is used in each case.
	L-N Voltage	L-N Voltage	The phase-to-neutral (line-to-neutral) voltage system is used for static threshold detection of VFRT Region 3.
	L-L Voltage		The phase-to-phase (line-to-line) voltage system is used for static threshold detection of VFRT Region 3.
	L-L and L-N Voltage		Both voltage systems (line-to-neutral and line-to-line) are used for static threshold detection of VFRT Region 3.

Parameter	Value range	Standard value	Description
"Current Calc Mode"			Current inrush mode for Region 3. This parameter defines the type of current feed during a Region 3 voltage fault.
	Passive		The pre-fault active current and reactive current is maintained for as long as the fault persists.
	Zero Current	Zero Current	The alternating current is adjusted to zero. There is no effective or reactive power feed-in during the fault.
	Active Symmetric Current		A symmetrical reactive current (positive-sequence system reactive current) is fed into the grid. The additional reactive current value results from the " <b>k-factor Positive Sequence</b> " multiplied by the amount of the voltage dip. No active current is fed in.
	Active Asymmetric Current		An additional reactive current is fed into the grid. At the same time, active current is fed in (whereby the reactive current has priority). The additional reactive current value results from the k-factors multiplied by the voltage dip value. If the " <b>k-factor Negative Sequence</b> " is set to 0, the feed is symmetrical. Otherwise, asymmetrical faults are responded to with an asymmetrical current infeed.
"k-factor Positive Sequence"	0 - 10	2.0	Multiplication factor (k-factor) for the positive-sequence system reactive current in Region 3. Only applied with current inrush mode " <b>Active Symmetric Current</b> " and " <b>Active Asymmetric Current</b> ".



Parameter	Value range	Standard value	Description
"k-factor Negative Sequence"	0 - 10	2.0	Multiplication factor (k-factor) for the negative-sequence system reactive current in Region 3. Only applied with current inrush mode " <b>Active Asymmetric Current</b> ". If an asymmetrical feed is required, this is usually set to the same value as " <b>k-factor Positive Sequence</b> ". If a symmetrical supply is required, this is set to 0.

## Active Power

### Voltage-dependent Power Control

or also called Volt/Watt function or P(U) function, causes a change in effective power depending on the mains voltage. By reducing the effective power at high mains voltage (or increasing the effective power at low mains voltage), an unintentional switch-off of the inverter due to the overvoltage or undervoltage limits can be avoided. This makes the yield losses less than they would be if the inverter was switched off.

When the function is activated and the specified mains voltage limit value is exceeded, the effective power

- is reduced according to a defined gradient if the mains voltage is too high (see example "**System without storage**" - red characteristic curve)
- is increased according to a defined gradient if the mains voltage is too low (only possible with hybrid inverters, see example "**System with storage**" - green characteristic curve).

In the case of a hybrid inverter with active grid support activated ("**Active Grid Support**"), additional scenarios arise:

- If the output power has already been reduced to 0 W when the voltage is too high and the voltage continues to rise, additional energy can be taken from the national grid (the battery is thus charged, see "**System with storage and active grid support enabled**" - blue characteristic curve in the lower "**Power Input**" area).
- If the charging power (drawn from the national grid) has been reduced to 0 W when the voltage is too low and the voltage continues to drop, additional energy can be drawn from the battery to increase the output power (see example "**System with storage and active grid support enabled**" - blue characteristic curve in the upper "**Power Output**" area).

**Examples of active grid support:**

<b>"System without storage" (graph - red characteristic curve)</b>	<b>Description of the parameter</b>
<ul style="list-style-type: none"> <li>- <b>"Mode"</b>: On (without Hysteresis)</li> <li>- No battery in the system</li> <li>- <b>"Active Grid Support"</b>: Off</li> <li>- <b>"Calculation Mode"</b>: <math>P_{max} = P_m - P_n(k \cdot df)</math></li> </ul>	<ul style="list-style-type: none"> <li>(1) Momentary effective power when the <b>"Activation Threshold Overvoltage"</b> is reached: 50 % of <math>P_n</math> (equipment - nominal output)</li> <li>(2) <b>"Activation Threshold Overvoltage"</b>: 250 V</li> <li>(3) <b>"Gradient Overvoltage"</b>: 7.5 %/V</li> </ul>
<b>"System with storage and active grid support disabled" (graphic - green characteristic curve)</b>	<b>Description of the parameter</b>
<ul style="list-style-type: none"> <li>- <b>"Mode"</b>: On (without Hysteresis)</li> <li>- Battery is active</li> <li>- <b>"Active Grid Support"</b>: Off</li> <li>- <b>"Calculation Mode"</b>: <math>P_{max} = P_m - P_n(k \cdot df)</math></li> </ul>	<ul style="list-style-type: none"> <li>(1) (4) Momentary effective power when the respective <b>"Activation Threshold"</b> is reached: 50 % of <math>P_n</math> (equipment - nominal output)</li> <li>(2) <b>"Activation Threshold Overvoltage"</b>: 250 V</li> <li>(3) <b>"Gradient Overvoltage"</b>: 7.5 %/V</li> <li>(5) <b>"Activation Threshold Undervoltage"</b>: 210 V</li> <li>(6) <b>"Gradient Undervoltage"</b>: 7.5 %/V</li> </ul>
<b>"System with storage and active grid support enabled" (graphic - blue characteristic curve)</b>	<b>Description of the parameter</b>
<ul style="list-style-type: none"> <li>- <b>"Mode"</b>: On (without Hysteresis)</li> <li>- Battery is active</li> <li>- <b>"Active Grid Support"</b>: On</li> <li>- <b>"Calculation Mode"</b>: <math>P_{max} = P_m - P_n(k \cdot df)</math></li> </ul>	<ul style="list-style-type: none"> <li>(1) (4) Momentary effective power when the respective <b>"Activation Threshold"</b> is reached: 50 % of <math>P_n</math> (equipment - nominal output)</li> <li>(2) <b>"Activation Threshold Overvoltage"</b>: 250 V</li> <li>(3) <b>"Gradient Overvoltage"</b>: 7.5 %/V</li> <li>(5) <b>"Activation Threshold Undervoltage"</b>: 210 V</li> <li>(6) <b>"Gradient Undervoltage"</b>: 7.5 %/V</li> </ul>

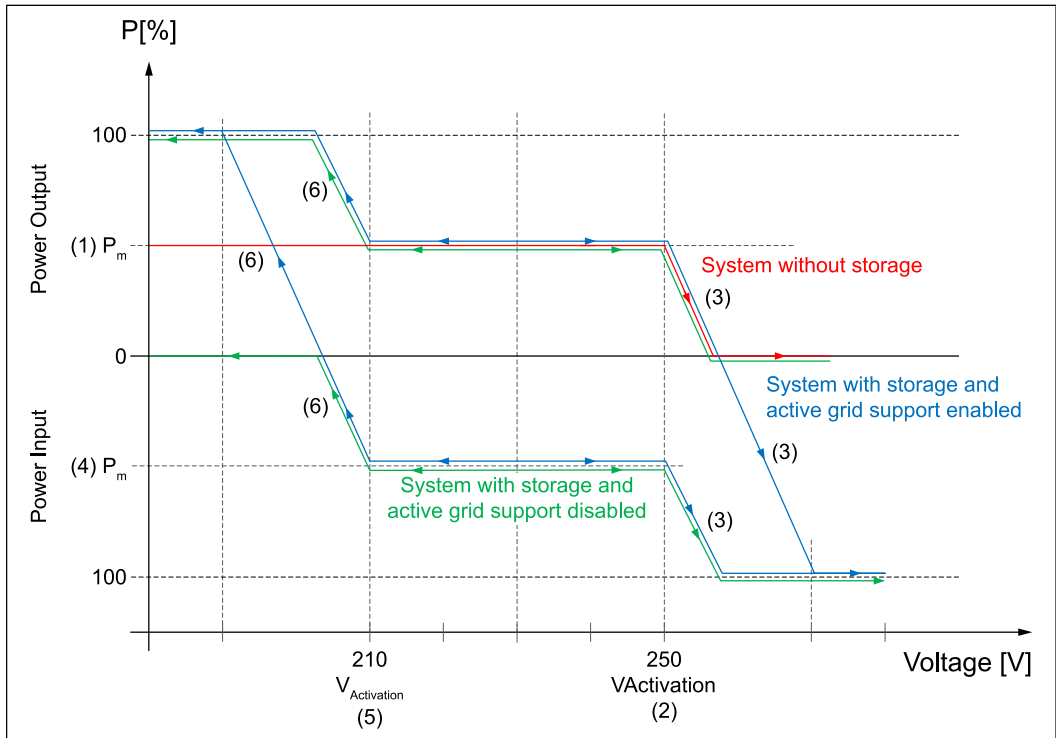

General power curve depending on mains voltage.

SOC (State Of Charge) limits can be set for active grid support with battery. If a limit is reached, the battery is no longer used for active grid support. These can be found under **"Battery SoC Limitation for Grid Support"**:

- **"Battery SoC Lower Limit"** - The battery will not be further discharged when the lower limit is reached.
- **"Battery SoC Upper Limit"** - The battery will not be further charged when the upper limit is reached.

Parameter	Value range	Description	Availability
<b>"Mode"</b>	Off	The function is deactivated.	
	On (without Hysteresis)	The function is activated.	
<b>"Activation Threshold Overvoltage"</b>	208 - 311 [V]	Mains voltage limit value above which the power reduction takes place.	
<b>"Gradient Overvoltage"</b>	0.01 - 100 [%/V]	Gradient by which the effective power is reduced.  <b>Example</b> - conversion from static to gradient: Static $s = 4\%$ $\rightarrow$ Gradient $k = 1/(0.04 * 230\text{ V}) = 10.9\%/V$	

Parameter	Value range	Description	Availability
"Calculation Mode"	$P_{max} = P_m - P_m(k \cdot dV)$  $P_{max} = P_n - P_n(k \cdot dV)$  $P_{max} = P_m - P_n(k \cdot dV)$	<p>Indicates the reference power for calculating the power limit in the event of overvoltage or undervoltage.</p> <p><b>Reference power:</b></p> <ul style="list-style-type: none"> <li>- <math>P_m \rightarrow</math> Momentary power when the mains voltage limit value is exceeded.</li> <li>- <math>P_n \rightarrow</math> Nominal output of the device.</li> </ul>	
"Active Grid Support"	Off	Deactivates extended active grid support for devices with a battery.	<p><b>Has no influence on the following setups:</b></p> <ul style="list-style-type: none"> <li>- AUS Region A 2020</li> <li>- AUS Region B 2020</li> <li>- AUS Region C 2020</li> <li>- NZS 2020</li> </ul>
	On	Activates extended active grid support for devices with a battery.	
"Activation Threshold Undervoltage"	0 - 311 [V]	Mains voltage limit value above which the power increase takes place.	
"Gradient Undervoltage"	0 - 100 [%/V]	<p>Gradient by which the effective power increases.</p> <p><b>Example</b> - conversion from static to gradient:  Static <math>s = 4\%</math> <math>\rightarrow</math> Gradient <math>k = 1 / (0.04 \cdot 230\text{ V}) = 10.9\%</math>/V</p>	
"Time Constant ( $\tau$ )"	0 - 600 [s]	Time constant (1 Tau) in seconds [s]. Whenever the set value is changed, this new set value is not triggered abruptly, but smoothly in accordance with a PT1 response. The time constant describes how quickly the new set value is reached. (After three time constants the final value 95 % is reached)	

Parameter	Value range	Description	Availability
"Stop Voltage at Overvoltage"	0 - 311 [V]	Mains voltage limit value up to which the power reduction takes place. The gradient is automatically calculated from the parameters " <b>Activation Threshold Overvoltage</b> " and " <b>Power at Stop Voltage at Overvoltage</b> ". The parameters " <b>Gradient Overvoltage</b> " and " <b>Calculation Mode</b> " have no function.	<b>Used exclusively in the following setups:</b> <ul style="list-style-type: none"> <li>- AUS Region A 2020</li> <li>- AUS Region B 2020</li> <li>- AUS Region C 2020</li> <li>- NZS 2020</li> </ul>
"Power at Stop Voltage - Overvoltage"	0 - 100 [%]	Reference power when the set mains voltage limit value is reached.	

Example: Setups AUS/NSZ 2020	Description of the parameter
- " <b>Mode</b> ": On (without hysteresis)	(1) " <b>Activation Threshold Overvoltage</b> ": 250 V (2) " <b>Stop at Voltage at Overvoltage</b> ": 260 V (3) " <b>Power at Stop Voltage - Overvoltage</b> ": 20 %

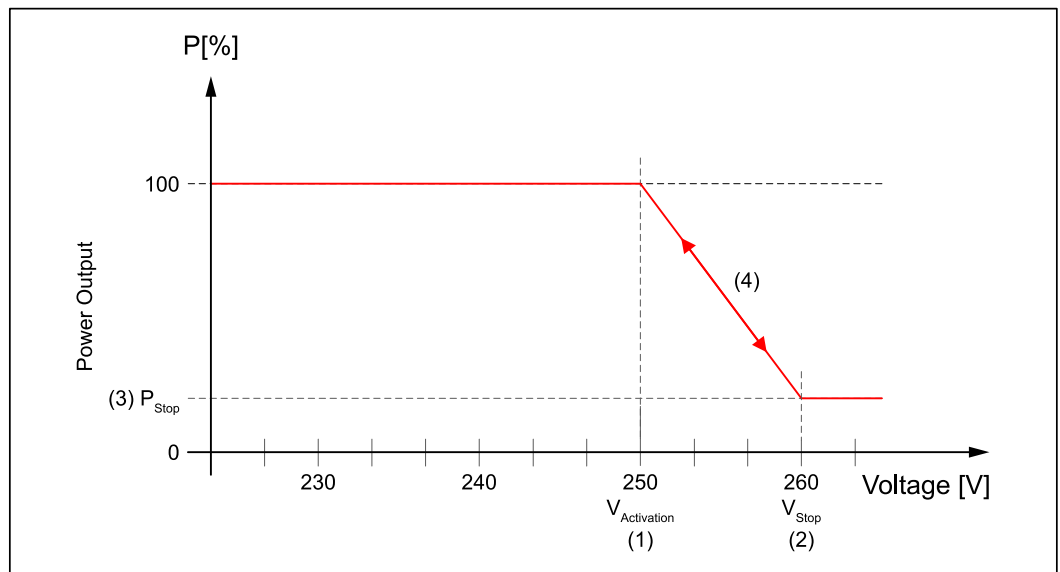

Power curve when "**Activation Threshold Overvoltage**" is exceeded.

Parameter	Value range	Description	Availability
"Stop Voltage at Undervoltage"	200 - 311 [V]	Mains voltage limit value up to which the charging power of the battery is reduced. The gradient is calculated automatically from the parameters "Activation Threshold Undervoltage" and "Power at Stop Voltage at Undervoltage". The parameters "Gradient Undervoltage" and "Calculation Mode" have no function.	<b>Used exclusively in the following setups:</b> <ul style="list-style-type: none"> <li>- AUS Region A 2020</li> <li>- AUS Region B 2020</li> <li>- AUS Region C 2020</li> <li>- NZS 2020</li> </ul>
"Power at Stop Voltage - Undervoltage"	0 - 100 [%]	Reference power when the set mains voltage limit value is reached. Only for devices with battery in charging mode.	

Example: Setups AUS/NSZ 2020	Description of the parameter
- "Mode": On (without hysteresis)	(1) "Activation Threshold Undervoltage": 210 V (2) "Stop at Voltage at Undervoltage": 200 V (3) "Power at Stop Voltage - Undervoltage": 20 %

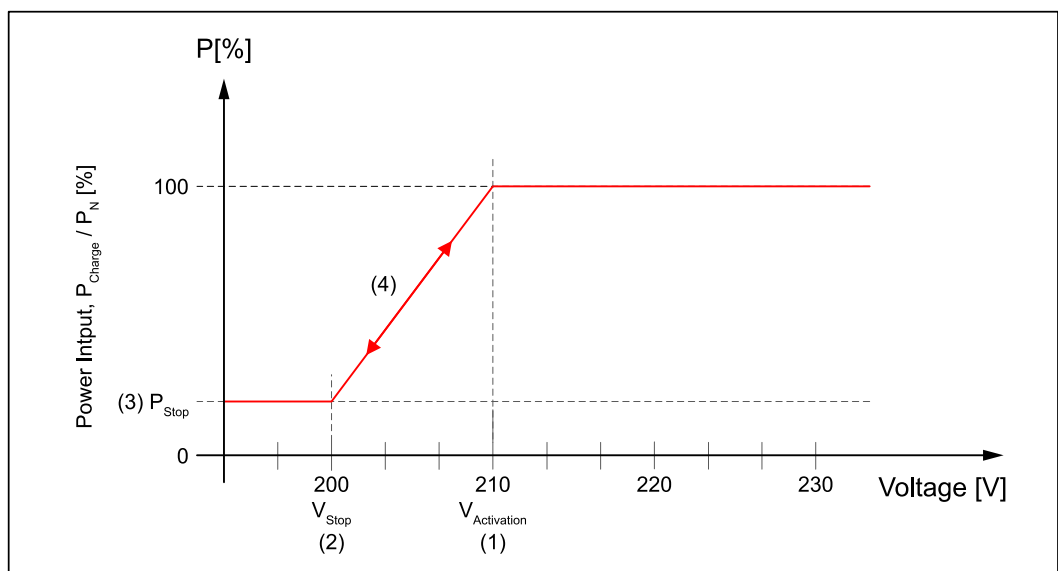

Charge power limitation when "Activation Threshold Undervoltage" is exceeded.

### Frequency-dependent Power Control

, also called frequency/watt function or P(f) function, causes a change in effective power depending on the mains frequency.

A distinction is made between:

- Overfrequency
- Underfrequency

When the function is activated and the specified mains frequency limit value is exceeded, the effective power

- is reduced according to a defined gradient in the event of an overfrequency (in the case of an inverter with an energy storage device, discharge of the storage device is stopped first before the power of the PV generator is reduced).
- is increased in the event of underfrequency in accordance with a defined gradient (in the case of an inverter without an energy storage device or with active grid support deactivated, only possible in conjunction with a manual power reduction and corresponding priority).

The gradients result depending on the parameter "**Configuration Method**":

- "**Gradient**": The gradient is given in %/Hz in relation to the device nominal output or the momentary power when entering the function (see example 1).
- "**Stop Frequency**": With this method, the gradient always results from the current power at entry into the function to the stop frequency set in the setup and power at stop frequency (see example 2).

In the case of an inverter with an energy storage device and active grid support activated, additional scenarios arise:

- If the output power has already been reduced to 0 W at overfrequency and the frequency continues to rise, additional energy can be drawn from the grid (the battery is thus charged).
- If the charging power (drawn from the grid) is reduced to 0 W at underfrequency and the frequency continues to drop, additional energy can be drawn from the battery to increase the output power.

SOC (State Of Charge) limits can be set for active grid support with battery.

These can be found under "**Battery SoC Limitation for Grid Support**":

- "**Battery SoC Lower Limit**" - The battery will not be further discharged when the lower limit is reached.
- "**Battery SoC Upper Limit**" - The battery will not be further charged when the upper limit is reached.

Once the mains frequency falls within the permitted frequency range again following successful power reduction, a return to the full power available takes place depending on the country setup as follows:

- Mode: "**On (without Hysteresis)**"  
The inverter increases the power from the current reduced value to the original value in accordance with the same gradient used for power reduction.
- Mode: "**On (with Hysteresis)**"  
The inverter will not increase the power to the original value until the frequency is back in the target value range for a specific length of time.

Example 1	Description of the parameter
<ul style="list-style-type: none"> <li>- "P(f) Mode": On (without Hysteresis)</li> <li>- "Configuration Method": Gradient</li> <li>- "Active Grid Support": Off</li> <li>- "Calculation Mode Underfrequency": <math>P_{max} = P_m - P_n(k \cdot df)</math></li> <li>- "Calculation Mode Overfrequency": <math>P_{max} = P_m - P_n(k \cdot df)</math></li> </ul>	<p>(1) Momentary effective power when the respective "Activation Threshold" is reached: 60 % of <math>P_n</math> (nominal output).</p> <p>(2) "Gradient Underfrequency": 80 %/Hz - Increase of output power without battery only possible if sufficient power from the PV generator is available and manual power limitation is active. For this purpose, the "Priority at Underfrequency" parameter must be set to "Priority on Frequency-dependent Power Limitation".</p> <p>(3) "Activation Threshold Underfrequency": 49.7 Hz</p> <p>(4) "Gradient Overfrequency": 60%/Hz</p> <p>(5) "Activation Threshold Overfrequency": 50.3 Hz</p>

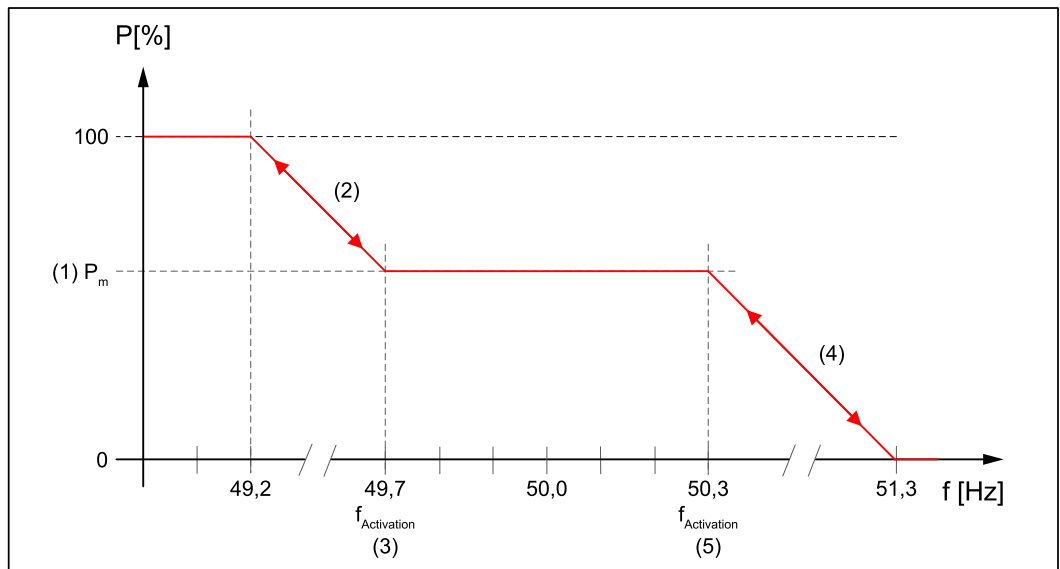

General power curve with overfrequency and underfrequency without hysteresis with gradients.



Example 2	Description of the parameter
<ul style="list-style-type: none"> <li>- "P(f) Mode": On (without Hysteresis)</li> <li>- "Configuration Method": Stop frequency</li> <li>- "Active Grid Support": Off</li> </ul>	<ul style="list-style-type: none"> <li>(1) Momentary effective power when the respective "Activation Threshold" is reached: 60 % of <math>P_n</math> (nominal output).</li> <li>(2) "Activation Threshold Underfrequency": 49.7 Hz</li> <li>(3) "Stop Frequency - Underfrequency": 49.0 Hz</li> <li>(4) "Power at Stop Frequency - Underfrequency": 85 %</li> <li>(5) "Activation Threshold Overfrequency": 50.3 Hz</li> <li>(6) "Stop Frequency - Overfrequency": 51.3 Hz</li> <li>(7) "Power at Stop Frequency - Overfrequency": 20 %</li> </ul>

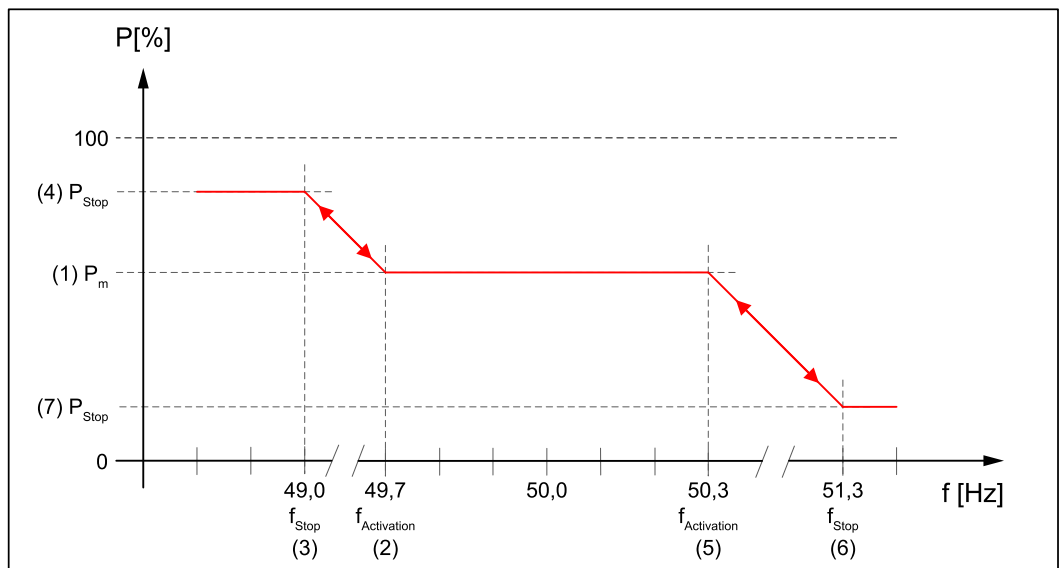

General power curve with overfrequency and underfrequency without hysteresis with stop frequency.

Example 3	Description of the parameter
- "P(f) Mode": On (with Hysteresis)	(1) Momentary effective power when the respective "Activation Threshold" is reached: 60 % of P <sub>n</sub> (nominal output).
- "Configuration Method": Gradient	(2) "Gradient Underfrequency": 80 %/Hz
- "Active Grid Support": Off	(3) "Activation Threshold Underfrequency": 49.7 Hz
- "Calculation Mode Underfrequency": P <sub>max</sub> = P <sub>m</sub> - P <sub>n</sub> (k*df)	(4) "Lower Deactivation Threshold Underfrequency": 49.9 Hz
- "Calculation Mode Overfrequency": P <sub>max</sub> = P <sub>m</sub> - P <sub>n</sub> (k*df)	(5) "Upper Deactivation Threshold Overfrequency": 50.1 Hz
	(6) "Gradient Overfrequency": 60 %/Hz
	(7) "Activation Threshold Overfrequency": 50.3 Hz
	(8) "Lower Deactivation Threshold Overfrequency": 49.9 Hz
	(9) "Upper Deactivation Threshold Overfrequency": 50.1 Hz
	(10) "Deactivation Time": 30 s

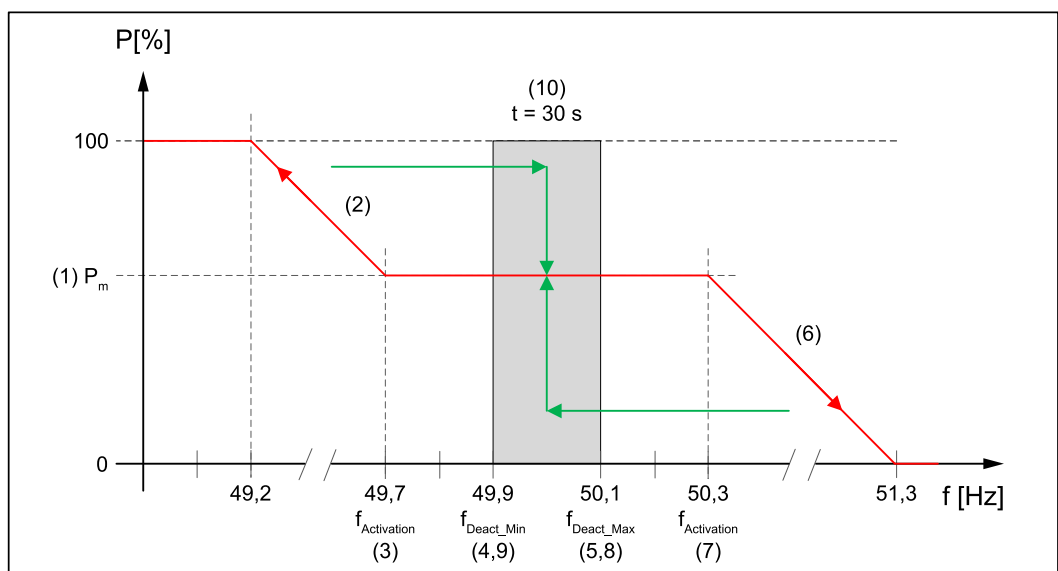

General power curve with overfrequency and underfrequency with hysteresis with gradients.

Parameter	Value range	Description	Availability
"Mode"	Off	The function is deactivated.	
	On (with Hysteresis)	Function is activated with hysteresis.	
	On (without Hysteresis)	Function is activated without hysteresis.	<p><b>In the following setups "On (without Hysteresis)" is not possible:</b></p> <ul style="list-style-type: none"> <li>- AUS Region A 2020</li> <li>- AUS Region B 2020</li> <li>- AUS Region C 2020</li> <li>- NZS 2020</li> </ul>
"Configuration Method"	Gradient	For calculating the power limitation depending on the parameters " <b>Gradient Overfrequency</b> " or " <b>Gradient Underfrequency</b> ".	
	Stop - Frequency	The gradient is calculated automatically using the parameters " <b>Stop Frequency - Overfrequency</b> " and " <b>Power at Stop Frequency - Overfrequency</b> " as well as " <b>Stop Frequency - Underfrequency</b> " and " <b>Power at Stop Frequency - Underfrequency</b> ".	
"Active Grid Support"	Off	Deactivates extended active grid support for devices with a battery.	<p><b>Has no influence on the following setups:</b></p> <ul style="list-style-type: none"> <li>- AUS Region A 2020</li> <li>- AUS Region B 2020</li> <li>- AUS Region C 2020</li> <li>- NZS 2020</li> </ul>
	On	Activates extended active grid support for devices with a battery.	

## Overfrequency

Parameter	Value range	Description	Availability
"Calculation Mode Overfrequency"	$P_{max} = P_m - P_m(k \cdot df)$	Indicates the reference power for calculating the power limit in the event of overfrequency.  <b>Reference power</b> - $P_m \rightarrow$ Momentary power when the frequency limit value is exceeded. - $P_n \rightarrow$ Nominal output of the device.	
	$P_{max} = P_n - P_n(k \cdot df)$		
	$P_{max} = P_m - P_n(k \cdot df)$		
"Activation Threshold Overfrequency"	45 - 66 [Hz]	Frequency limit value above which the power reduction takes place.	
"Gradient Overfrequency"	0.01 - 300 [%/Hz]	Gradient by which the effective power is reduced.  <b>Example</b> - conversion from static to gradient: Static $s = 5\%$ $\rightarrow$ Gradient $k = 1/(0.05 \cdot 50\text{Hz}) = 40\%$ /Hz	
"Stop Frequency - Overfrequency"	45 - 66 [Hz]	Frequency value at which the power reduction ends.	
"Power at Stop Frequency - Overfrequency"	-100 - 0 [%]	Power when the set frequency limit value "Stop Frequency - Overfrequency" is reached. Adjustable between 0 % and full charging power (-100 %).	
"Upper Deactivation Threshold Overfrequency"	45 - 66 [Hz]	Used if "Mode" is set to "On (with Hysteresis)". If the mains frequency falls below this value, the frequency-dependent power reduction is terminated, taking into account the settings under "Frequency-dependent Power Control - General".	

Parameter	Value range	Description	Availability
"Lower Deactivation Threshold Overfrequency"	45 - 66 [Hz]	Used if "Mode" is set to "On (with Hysteresis)". If this value is less than the "Upper Deactivation Threshold Overfrequency", a frequency window results in which the mains frequency must be located to terminate the function. If this value is greater than or equal to the "Upper Deactivation Threshold Overfrequency", it is not applied.	
"Transition Frequency at Overfrequency"	45 - 66 [Hz]	Frequency at which the device with active battery reaches an output power of 0 W. If the mains frequency continues to rise, energy is drawn from the national grid and thus the battery is charged. If there is no battery in the system or it is not active, this parameter has no function (behavior as in example 3 - overfrequency).	<b>Used exclusively in the following setups:</b> <ul style="list-style-type: none"> <li>- AUS Region A 2020</li> <li>- AUS Region B 2020</li> <li>- AUS Region C 2020</li> <li>- NZS 2020</li> </ul>

Example 4: Setups AUS/NSZ 2020	Description of the parameter
<ul style="list-style-type: none"> <li>- <b>"P(f) Mode"</b>: On (with Hysteresis)</li> <li>- <b>"Active Grid Support"</b>: On</li> <li>- Battery is active</li> </ul>	<ol style="list-style-type: none"> <li>(1) Momentary effective power when the respective <b>"Activation Threshold"</b> is reached: 60 % of <math>P_n</math> (nominal output).</li> <li>(2) The gradient for power reduction in generator-powered operation at overfrequency results automatically from the two set parameters <b>"Activation Threshold Overfrequency"</b> and <b>"Transition Frequency at Overfrequency"</b></li> <li>(3) <b>"Activation Threshold Overfrequency"</b>: 50.25 Hz</li> <li>(4) <b>"Transition Frequency at Overfrequency"</b>: 50.75 Hz</li> <li>(5) The gradient for increasing the charging power at overfrequency results automatically from the two set parameters <b>"Transition Frequency at Overfrequency"</b> and <b>"Stop Frequency - Overfrequency"</b>. Depending on the set country setup, the power at stop frequency refers to drawing 100 % from the national grid. The parameter <b>"Power at Stop Frequency - Overfrequency"</b> has no function in these countries.</li> <li>(6) <b>"Stop Frequency - Overfrequency"</b>: 52.0 Hz</li> <li>(7) <b>"Upper Deactivation Threshold Overfrequency"</b>: 50.0 Hz - When the mains frequency returns to or below the set limit value, the effective power may be increased again.</li> <li>(8) <b>"Deactivation Time"</b>: 20 s - The frequency must be in the valid range for at least this time before the function is terminated.</li> <li>(9) <b>"Return Gradient 1"</b>: Return to power before entering P(f) in percent per second.</li> </ol>

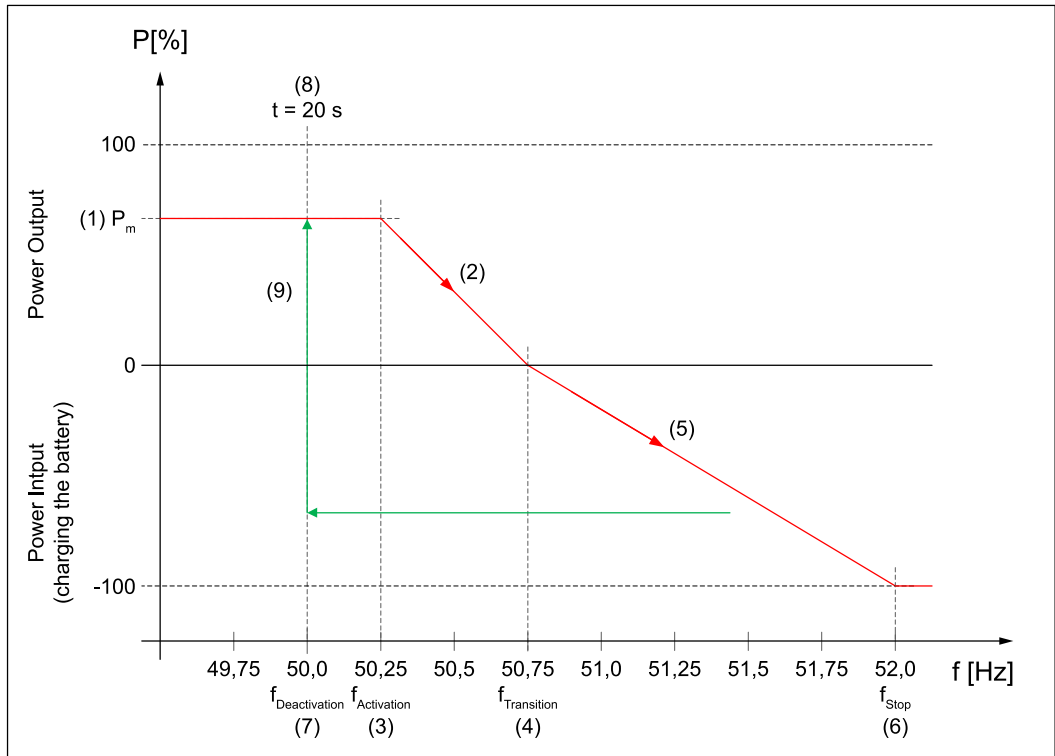

Power curve at overfrequency with hysteresis.

### Underfrequency

Parameter	Value range	Description	Availability
"Calculation Mode Underfrequency"	$P_{max} = P_m - P_m(k \cdot df)$	Indicates the reference power for calculating the power limit in the event of underfrequency.  <b>Reference power</b> - $P_m \rightarrow$ Momentary power when the frequency limit value is exceeded. - $P_n \rightarrow$ Nominal output of the device.	
	$P_{max} = P_n - P_n(k \cdot df)$		
	$P_{max} = P_m - P_n(k \cdot df)$		
"Activation Threshold Underfrequency"	45 - 66 [Hz]	Frequency limit value above which the power increase takes place.	
"Gradient Underfrequency"	0 - 100 [%/Hz]	Gradient by which the effective power increases.  <b>Example</b> - conversion from static to gradient: Static $s = 5\% \rightarrow$ Gradient $k = 1/(0.05 \cdot 50\text{Hz}) = 40\%/\text{Hz}$	
"Stop Frequency - Underfrequency"	45 - 66 [Hz]	Frequency value at which the power increase ends.	

Parameter	Value range	Description	Availability
"Power at Stop Frequency - Underfrequency"	0 - 100 [%]	Power when the set frequency limit value " <b>Stop Frequency - Underfrequency</b> " is reached. Adjustable between 0 % and full feed-in power (100 %).	
"Upper Deactivation Threshold Underfrequency"	45 - 66 [Hz]	Used when " <b>Mode</b> " is set to " <b>On (with Hysteresis)</b> ". If this value is greater than the " <b>Lower Deactivation Threshold Underfrequency</b> ", there is a frequency window in which the mains frequency must be to terminate the function. If this value is less than or equal to the " <b>Lower Deactivation Threshold Underfrequency</b> ", it is not applied.	
"Lower Deactivation Threshold Underfrequency"	45 - 66 [Hz]	In use when " <b>Mode</b> " - " <b>On (with Hysteresis)</b> " is set. If the mains frequency exceeds this value, the function is terminated, taking into account the settings under " <b>Frequency-dependent Power Control - General</b> ".	
"Transition Frequency at Underfrequency"	45 - 66 [Hz]	Frequency at which the device with active battery reaches an output power of 0 W (charging power is reduced). If the mains frequency continues to drop, additional energy is released into the grid. This energy can come from the PV generator or from the battery. If there is no battery in the system or it is not active, this parameter has no function (behavior as in example 3 - underfrequency).	<b>Used exclusively in the following setups:</b> <ul style="list-style-type: none"> <li>- AUS Region A 2020</li> <li>- AUS Region B 2020</li> <li>- AUS Region C 2020</li> <li>- NZS 2020</li> </ul>



Example 5: Setups AUS/NSZ 2020	Description of the parameter
<ul style="list-style-type: none"> <li>- <b>"P(f) Mode"</b>: On (with Hysteresis)</li> <li>- <b>"Active Grid Support"</b>: On</li> <li>- Battery is active</li> </ul>	<ol style="list-style-type: none"> <li>(1) Momentary draw (charging power of the battery) when the respective "Activation Threshold" (3) is reached: 80 % of <math>P_n</math> (nominal output)</li> <li>(2) The gradient for reducing the charging power at underfrequency results automatically from the two set parameters <b>"Activation Threshold Underfrequency" (3)</b> and <b>"Transition Frequency at Underfrequency" (4)</b></li> <li>(3) <b>"Activation Threshold Underfrequency"</b>: 49.75 Hz</li> <li>(4) <b>"Transition Frequency at Underfrequency"</b>: 49.0 Hz</li> <li>(5) The gradient for increasing the output power at underfrequency results automatically from the two set parameters <b>"Transition Frequency at Underfrequency" (4)</b> and <b>"Stop Frequency - Underfrequency" (6)</b>. Depending on the set country setup, the power at stop frequency refers to 100 % output power (nominal output of the inverter). The parameter <b>"Power at Stop Frequency - Underfrequency"</b> has no function in these countries.</li> <li>(6) <b>"Stop Frequency - Underfrequency"</b>: 48.0 Hz</li> <li>(7) <b>"Lower Deactivation Threshold Underfrequency"</b>: 50.0 Hz - When the mains frequency returns to or above the set limit value, the effective power may return to the value before entering the function.</li> <li>(8) <b>"Deactivation Time"</b>: 20 s - The frequency must be in the valid range for at least this time before the function is terminated.</li> <li>(9) <b>"Return Gradient 1"</b>: Return to power before entering P(f) in percent per second.</li> </ol>

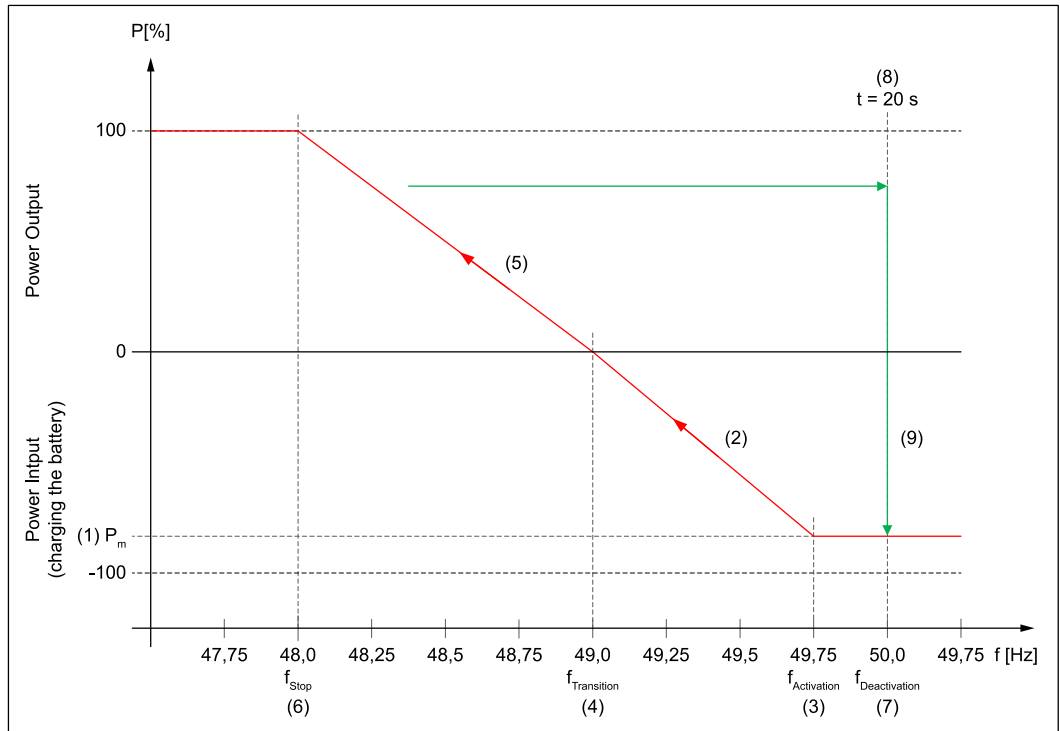

Power curve at underfrequency with hysteresis.

### General - Frequency-dependent Power Control

Parameter	Value range	Description	Availability
"Return Gradient 1"	0.01 - 100 [%/s ]	Rate of change at which the inverter increases the effective power after the limitation has ended.	
"Return Gradient 1 Alternative"	0.01 - 100 [%/s ]	Rate of change at which the inverter increases the effective power after the limitation has ended. This is activated if the difference between the rated power and the current reduced power is greater than the "Return Gradient 1 Alternative Threshold".	

Parameter	Value range	Description	Availability
"Return Gradient 1 Alternative Threshold"	0 - 100 [W%]	<p>Threshold value from which "Return Gradient 1" or "Return Gradient 1 Alternative" is applied.</p> <p><b>Example:</b>            If the difference between the rated power and the currently reduced power is less than or equal to the threshold value, "Return Gradient 1" is applied. If the difference between the rated power and the current reduced power is greater than or equal to the threshold, "Return Gradient 1 Alternative" is applied. 0.01 - 100 %. 100 % means that "Return Gradient 1" is always applied.</p>	

Example 6	Description of the parameter
	<p><math>P_m</math> Actual power at the moment the limit value is exceeded</p> <p><math>P_{red}</math> Reduced power</p> <p>(1) <b>"Gradient Overfrequency"</b></p> <p>(2) <b>"Deactivation Time"</b></p> <p>(3) <b>"Return Gradient 1"</b></p> <p>(4) <b>"Return Gradient 1 Alternative"</b></p> <p>(5) <b>"Return Gradient 1 Alternative Threshold": <math>P_m - P_{red} \leq 25 \%</math></b></p> <p>(6) <b>"Return Gradient 1 Alternative Threshold": <math>P_m - P_{red} &gt; 25 \%</math></b></p> <p>(7) <b>"Intentional Delay"</b></p> <p>The mains frequency returns to the permissible range at <math>P_{red}</math>. After the waiting time (2) has elapsed, the power is increased to the initial value <math>P_m</math> with one of the following gradients:</p> <p><b>Gradient 1 - red</b> The difference between the current power <math>P_m</math> and the reduced power <math>P_{red}</math> is <math>\leq</math> <b>"Return Gradient 1 Alternative Threshold"</b> of 25 % (5). Thus, the power is increased to the initial value <math>P_m</math> with <b>"Return Gradient 1"</b> (3).</p> <p><b>Gradient 2 - grey</b> The difference between the current power <math>P_m</math> and the reduced power <math>P_{red}</math> is <math>&gt;</math> <b>"Return Gradient 1 Alternative Threshold"</b> of 25 % (5). This increases the power to the output value <math>P_m</math> with <b>"Return Gradient 1 Alternative"</b> (4).</p>

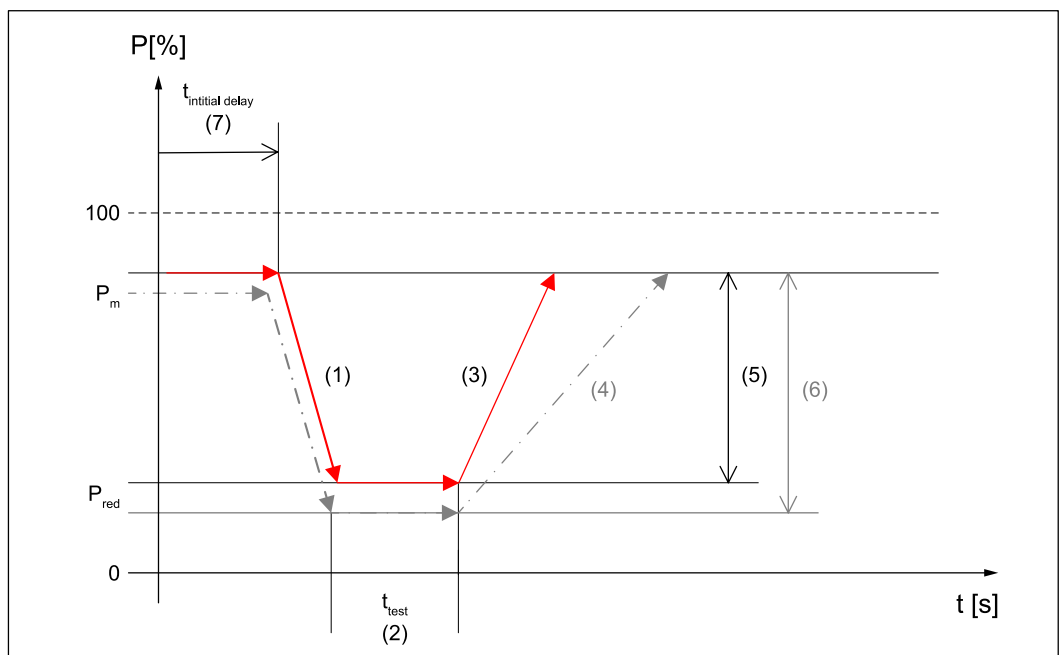

Application example with "Return Gradient 1 Alternative" and "Return Gradient 1 Alternative Threshold".

Parameter	Value range	Description	Availability
"Return Gradient 2 Mode"	Off	Deactivates the use of "Return Gradient 2". Raising the effective power from the reduced value to the device rated output takes place according to "Return Gradient 1".	
	On	Activates a different rate of change at which the inverter increases the effective power from the original value to the device nominal output. Raising the effective power from the original value to the device rated output takes place according to "Return Gradient 2".	
"Return Gradient 2"	0.01 - 100 [%/s ]	Rate of change at which the inverter increases the effective power from the original value to the device nominal output.	

Example 7	Description of the parameter
- "Return Gradient 2 Mode" = On	<p><math>P_m</math> Actual power at the moment the limit value is exceeded</p> <p><math>P_{red}</math> Reduced power</p> <p>(1) "Gradient Overfrequency"</p> <p>(2) "Deactivation Time"</p> <p>(3) "Return Gradient 1"</p> <p>(4) "Return Gradient 2"</p> <p>(5) "Intentional Delay"</p> <p>At <math>P_{red}</math> the mains frequency returns to the permissible range. After the end of the waiting time (2), the power is increased to the initial value <math>P_m</math> with "Return Gradient 1". The power is then increased to the device nominal output <math>P_n</math> with "Return Gradient 2" (4).</p>

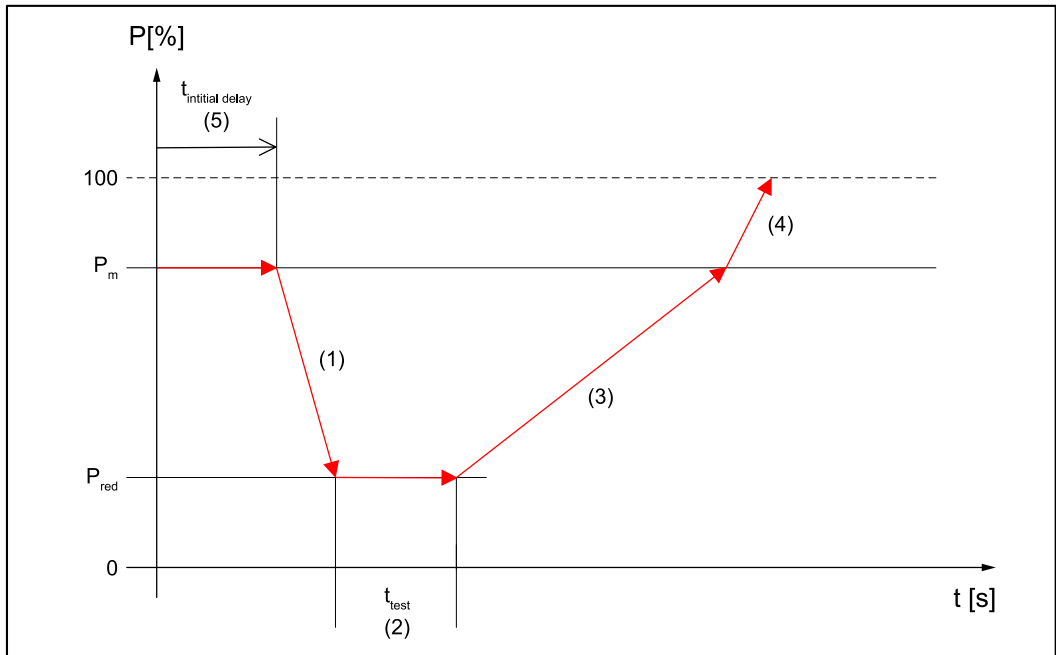

Application example with "Return Gradient 2 Mode".

Parameter	Value range	Description	Availability
"Deactivation Time"	0 - 600 [s]	Used when "Mode" is set to "On (with Hysteresis)". Waiting time after which the inverter increases the power again (after the mains frequency is again within the permitted frequency range between "Upper Deactivation Threshold" and "Lower Deactivation Threshold").	
"Intentional Delay"	0.5 - 60 [s]	Delays the start of the frequency-dependent power control after exceeding the respective "Activation Threshold".	
"Time Constant ( $\tau$ )"	0 - 60 [s]	Time constant (1 Tau) in seconds [s]. Whenever the set value is changed, this new set value is not triggered abruptly, but smoothly in accordance with a PT1 response. The time constant describes how quickly the new set value is reached. (After three time constants the final value 95 % is reached)	

## Battery SoC Limitation for Grid Support

Parameter	Value range	Description	Availability
"Mode"	Off	Deactivated SoC limitation	
	On	Activated SoC limitation	
"Battery SoC Lower Limit"	0 - 100 %	The battery is not further discharged when the lower limit is reached.	
"Battery SoC Upper Limit"	0 - 100 %	The battery is no longer charged when the upper limit is reached.	

---

## General - Active Power

Parameter	Value range	Description	Availability
"Priority at Underfrequency"	Priority on Manual Power Limitation	With " <b>Priority on Manual Power Limitation</b> " the power is not increased above the set limit in case of underfrequency.	
	Priority on Frequency-dependent Power Limitation	With " <b>Priority on Frequency-dependent Power Limitation</b> " the manual power limitation is ignored in case of underfrequency and the output power is increased depending on the frequency. The prerequisite is that sufficient energy is available from the PV generator or the battery.	

---

## Reactive power

The voltage in the national grid can be influenced by the controlled use of reactive power by the inverter. When using reactive power control, the effective power generated at the same time is not affected or is only affected to a small extent.

### IMPORTANT!

The exchange of reactive power (in addition to the feed-in of effective power) increases the current by the factor  $1/\cos \varphi$ .

Largely regardless of the effective power and therefore regardless of the energy yield, switching the reactive power can cause the voltage to both rise and to fall:

- In over-excited mode or capacitive mode, reactive power is supplied to the national grid. This increases the mains voltage.
  - In under-excited mode or inductive mode, reactive power is taken from the inverter. The mains voltage is lowered as a result.
-

### Potential operating range

Reactive power mode is restricted by the maximum apparent power  $S_n$  (and the maximum output current) as well as by the operational reactive power limits of the inverter:

- Primo GEN24:  $Q_{\max} = 60\%$  of  $S_n$  (or  $\cos \varphi = 0.80$  at  $S_n$ )
- Symo GEN24:  $Q_{\max} = 71\%$  of  $S_n$  (or  $\cos \varphi = 0.70$  at  $S_n$ )
- Tauro:  $Q_{\max} = 100\%$  of  $S_n$  (or  $\cos \varphi = 0.00$ )
- Verto:  $Q_{\max} = 100\%$  of  $S_n$  (or  $\cos \varphi = 0.00$ )

The value range specified for the following parameters may be additionally limited by the selected country-specific settings.

The following figure shows the possible operating range of the inverter. All valid operating points defined by effective power  $P$  and reactive power  $Q$  are within the grey area.

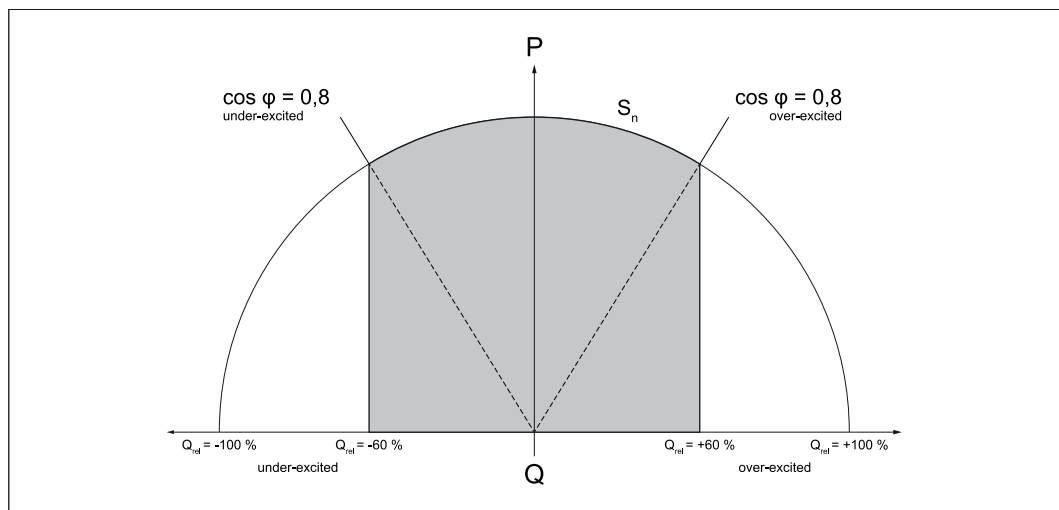

Example: Primo GEN24



## General settings

Parameter	Range of values	Description
"Mode"		Reactive power mode selection option. The following modes are described in the subchapters.
	Off	<b>No reactive power is fed in.</b>
	Cos $\varphi$ - Constant Power Factor	Constant Cos $\varphi$ .
	Q Absolute - Constant Reactive Power	Constant reactive power in [Var].
	Q Relative - Constant Reactive Power	Constant reactive power in percent [%] of $S_n$ .
	Cos $\varphi$ (P) - Power dependent Power Factor Characteristic	Effective power-dependent Cos $\varphi$ control.
	Q(P) - Power dependent Reactive Power Characteristic	Effective power-dependent reactive power control.
	Q(U) - Voltage dependent Reactive Power Characteristic	Mains voltage dependent reactive power control.
"P/Q Priority"	Q Priority	When the maximum apparent power is reached, the setting " <b>Q Priority</b> " leads to a reduction of the effective power in favor of reaching the reactive power specification.
	P Priority	The setting " <b>P Priority</b> " leads to a reduction of the reactive power in favor of reaching the available effective power when the maximum apparent power is reached.
"Cos $\varphi$ Minimum"	0 - 1	Minimum cos $\varphi$ , which together with the maximum apparent power forms an additional limitation of the reactive power at low effective power.

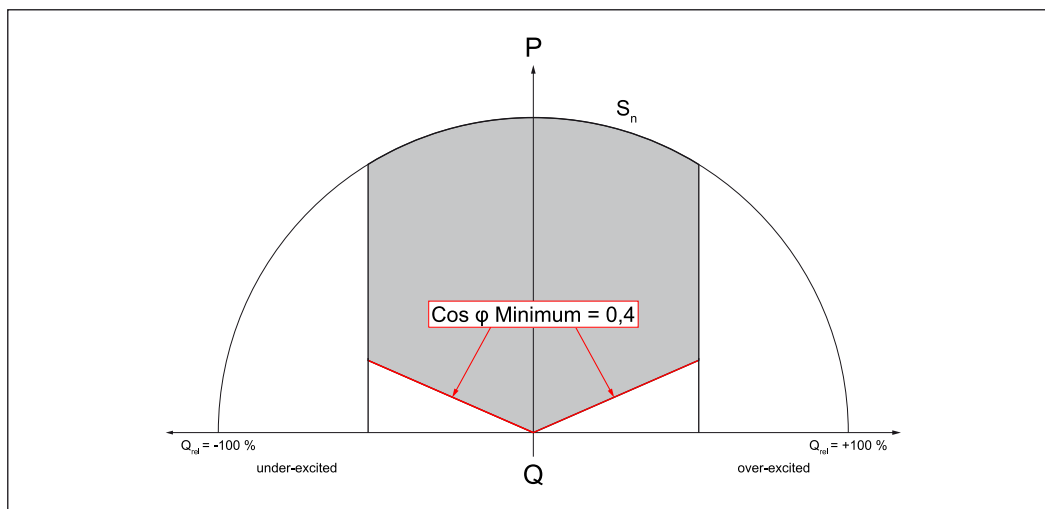

Depending on the selected mode, only the setting options in the respective subchapter and these general settings have an effect.

### const cos φ

Reactive power default defined by a constant cos φ. The function is limited by the maximum apparent power and Cos φ minimum, the P/Q priority has no effect.

Parameter	Range of values	Description
"cos φ - Power Factor"	0 - 1	Set value of Cos φ
"Direction / Excitation"	Over-Excited	Over-excited operation = capacitive operation = reactive power is supplied = reactive current is fed-in lagging the active current.
	Under-Excited	Under-excited operation = inductive operation = reactive power is drawn = reactive current is fed-in ahead of the active current.
"Time Constant (τ)"	0.01 s - 60 s	Time constant (1 Tau) in seconds [s]. Whenever the set value is changed, this new set value is not triggered abruptly, but smoothly in accordance with a PT1 response. The time constant describes how quickly the new set value is reached. (After three time constants the final value 95 % is reached)

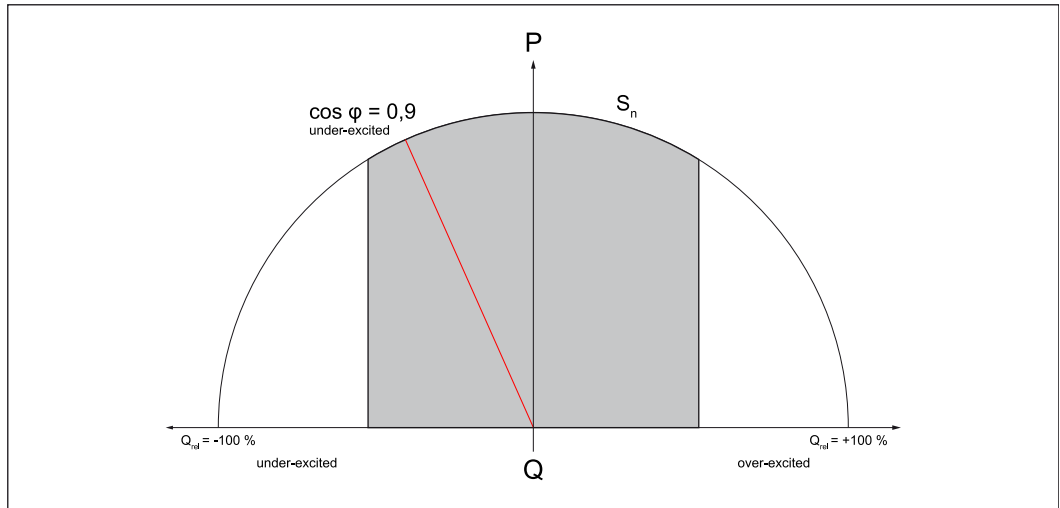

### Q Absolute - Constant Reactive Power

Reactive power specification defined by a constant value [Var]. The function is limited by the maximum apparent power and by "Cos φ Minimum"

Parameter	Range of values	Description
"Q - Reactive Power (Var)"	-200,000 Var - 200,000 Var	Reactive power setting value in [Var] (set value)
"Time Constant (τ)"	0.01 s - 60 s	Time constant (1 Tau) in seconds [s]. Whenever the set value is changed, this new set value is not triggered abruptly, but smoothly in accordance with a PT1 response. The time constant describes how quickly the new set value is reached. (After three time constants the final value 95 % is reached)

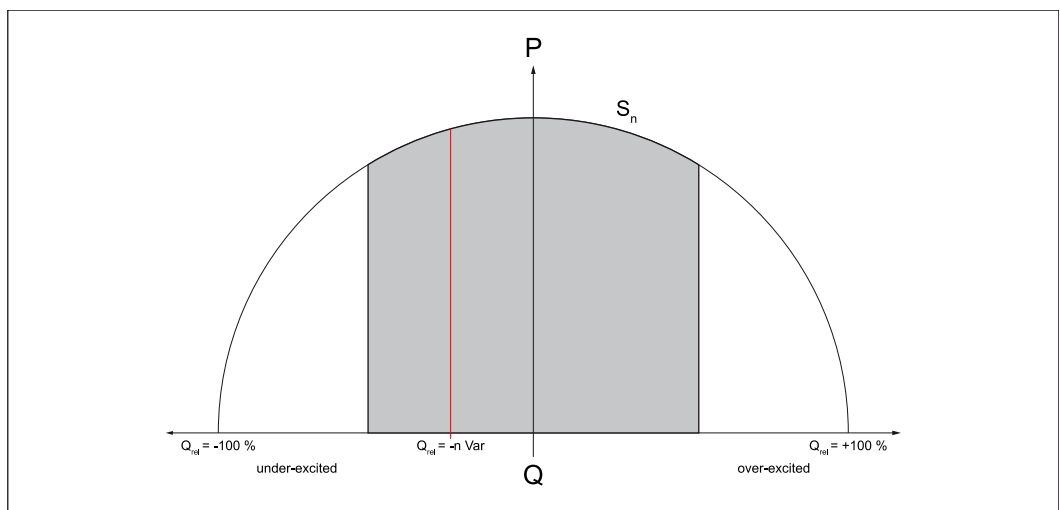

### Q Relative - Constant Reactive Power

Reactive power specification defined by a constant value in percent [%], related

to the nominal apparent power ( $S_n$ ) of the inverter. The function is limited by the maximum apparent power and by "**Cos  $\phi$  Minimum**".

Parameter	Range of values	Description
"Q - Reactive Power (% of Nominal Apparent Power)"	-100 % - 100 %	Reactive power setting as a percentage [%] of the nominal apparent power (set value)
"Time Constant ( $\tau$ )"	0.01 s - 60 s	Time constant (1 Tau) in seconds [s]. Whenever the set value is changed, this new set value is not triggered abruptly, but smoothly in accordance with a PT1 response. The time constant describes how quickly the new set value is reached. (After three time constants the final value 95 % is reached)

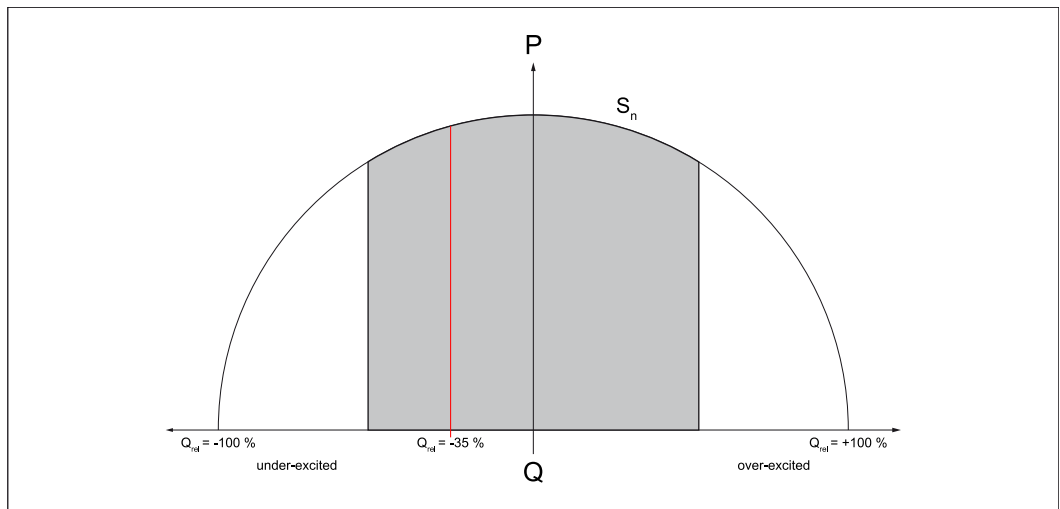

### **Cos $\phi$ (P) - Power dependent Power Factor Characteristic**

This function controls the  $\cos \phi$  depending on the momentary effective power according to a characteristic curve. The characteristic curve is defined by four data points (1-2-3-4). If fewer data points are required, the identical parameters can be set for two points. The function is limited by the maximum apparent

power and by "**Cos  $\varphi$  Minimum**". For the characteristic curves, the data points must be entered in the X-axis (effective power) and in the Y-axis (Cos  $\varphi$ ).

Point	Parameter	Range of values	Description
1	"Active Power (% of Nominal Apparent Power)"	0 % - 100 %	Effective power as a percentage of the nominal apparent power $S_N$ .
	"cos $\varphi$ - Power Factor"	0 - 1	Set value of Cos $\varphi$ .
	"Direction / Excitation"		The current direction corresponds to the generator counter arrow system.
		Under-Excited	Under-excited operation = inductive operation = reactive power is drawn = reactive current is fed-in ahead of the active current.
		Over-Excited	Over-excited operation = capacitive operation = reactive power is supplied = reactive current is fed-in lagging the active current.
2	"Active Power (% of Nominal Apparent Power)"	0 % - 100 %	Effective power as a percentage of the nominal apparent power $S_N$ .
	"cos $\varphi$ - Power Factor"	0 - 1	Set value of Cos $\varphi$ .
	"Direction / Excitation"		The current direction corresponds to the generator counter arrow system.
		Under-Excited	Under-excited operation = inductive operation = reactive power is drawn = reactive current is fed-in ahead of the active current.
		Over-Excited	Over-excited operation = capacitive operation = reactive power is supplied = reactive current is fed-in lagging the active current.

Point	Parameter	Range of values	Description	
3	"Active Power (% of Nominal Apparent Power)"	0 % - 100 %	Effective power as a percentage of the nominal apparent power $S_N$ .	
	"cos $\varphi$ - Power Factor"	0 - 1	Set value of Cos $\varphi$ .	
	"Direction / Excitation"			The current direction corresponds to the generator counter arrow system.
		Under-Excited		Under-excited operation = inductive operation = reactive power is drawn = reactive current is fed-in ahead of the active current.
		Over-Excited		Over-excited operation = capacitive operation = reactive power is supplied = reactive current is fed-in lagging the active current.
4	"Active Power (% of Nominal Apparent Power)"	0 % - 100 %	Effective power as a percentage of the nominal apparent power $S_N$ .	
	"cos $\varphi$ - Power Factor"	0 - 1	Set value of Cos $\varphi$ .	
	"Direction / Excitation"		The current direction corresponds to the generator counter arrow system.	
		Under-Excited	Under-excited operation = inductive operation = reactive power is drawn = reactive current is fed-in ahead of the active current.	
		Over-Excited	Over-excited operation = capacitive operation = reactive power is supplied = reactive current is fed-in lagging the active current.	

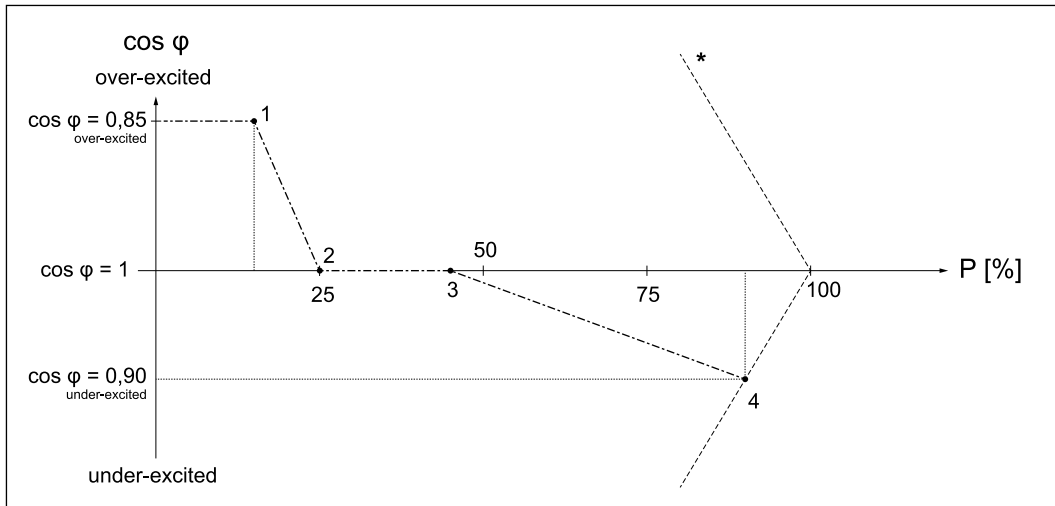

Example: Curve defined by four data points.

- 1 P = 15 %, cos φ = 0.85 - Over-Excited
- 2 P = 25 %, cos φ = 1 - Over-Excited
- 3 P = 45 %, cos φ = 1 - Over-Excited
- 4 P = 90 %, cos φ = 0.9 - Under-Excited

### General

In addition to the four points, the following parameters also come into play:

Parameter	Range of values	Description	Supplementary description
"Lock-In Voltage-Dependent (% of Nominal Voltage)"	0 % - 120 %	AC voltage as a percentage of the nominal voltage. If this value is exceeded, the Cos φ(P) characteristic is activated.	With the voltage-dependent Lock-In/ Lock-Out values it can be set that the Cos φ(P) control is deactivated at low voltages. The different values for activation (Lock-In) and deactivation (Lock-Out) enable a hysteresis to avoid unintentionally frequent switching on/off of the function. For this, the Lock-In value must be greater than the Lock-Out value.
"Lock-Out Voltage-Dependent (% of Nominal Voltage)"	0 % - 120 %	AC voltage as a percentage of the nominal voltage. If this value is undershot, the Cos φ(P) characteristic is deactivated. The lock-out limit has priority over the lock-in limit.	

Parameter	Range of values	Description	Supplementary description
"Lock-Out P-Dependent (% of Nominal Apparent Power)"	0 % - 100 %	Effective power as a percentage of the nominal apparent power $S_N$ . If this value is undershot, the $\text{Cos } \varphi(P)$ characteristic is deactivated.	With the effective power-dependent lock-out values, it can be set that the $\text{cos } \varphi(P)$ control is deactivated for small effective powers. For characteristic curves with a $\text{cos } \varphi$ not equal to 1 at data point 1, a $\text{cos } \varphi$ of 1 is approached again when the effective power value falls below this value. Otherwise, for effective powers that are lower than defined in data point 1, the $\text{cos } \varphi$ belonging to data point 1 remains active.
"Time Constant ( $\tau$ )"	0.01 s - 60 s	Time constant (1 Tau) in seconds [s]. Whenever the set value is changed, this new set value is not triggered abruptly, but smoothly in accordance with a PT1 response. The time constant describes how quickly the new set value is reached. (After three time constants the final value 95 % is reached)	

#### **Q(P) - Power dependent Reactive Power Characteristic**

This function controls the reactive power depending on the momentary effective power according to a characteristic curve. The characteristic curve is defined by four data points (1-2-3-4). If fewer data points are required, the identical parameters can be set for two points. The function is limited by the maximum apparent power and by "**Cos  $\varphi$  Minimum**". For the characteristic curves, the data



points in the X-axis (effective power) and in the Y-axis (reactive power) must be entered.

Point	Parameter	Range of values	Description
1	"Active Power (% of Nominal Apparent Power)"	0 % - 100 %	Effective power as a percentage of the nominal apparent power $S_n$ (X-axis).
	"Reactive Power (% of Nominal Apparent Power)"	-100 % - 100 %	Reactive power as a percentage of the nominal apparent power $S_n$ (Y-axis).
2	"Active Power (% of Nominal Apparent Power)"	0 % - 100 %	Effective power as a percentage of the nominal apparent power $S_n$ (X-axis).
	"Reactive Power (% of Nominal Apparent Power)"	-100 % - 100 %	Reactive power as a percentage of the nominal apparent power $S_n$ (Y-axis).
3	"Active Power (% of Nominal Apparent Power)"	0 % - 100 %	Effective power as a percentage of the nominal apparent power $S_n$ .
	"Reactive Power (% of Nominal Apparent Power)"	-100 % - 100 %	Reactive power as a percentage of the nominal apparent power $S_n$ (Y-axis).
4	"Active Power (% of Nominal Apparent Power)"	0 % - 100 %	Effective power as a percentage of the nominal apparent power $S_n$ (X-axis).
	"Reactive Power (% of Nominal Apparent Power)"	-100 % - 100 %	Reactive power as a percentage of the nominal apparent power $S_n$ (Y-axis).

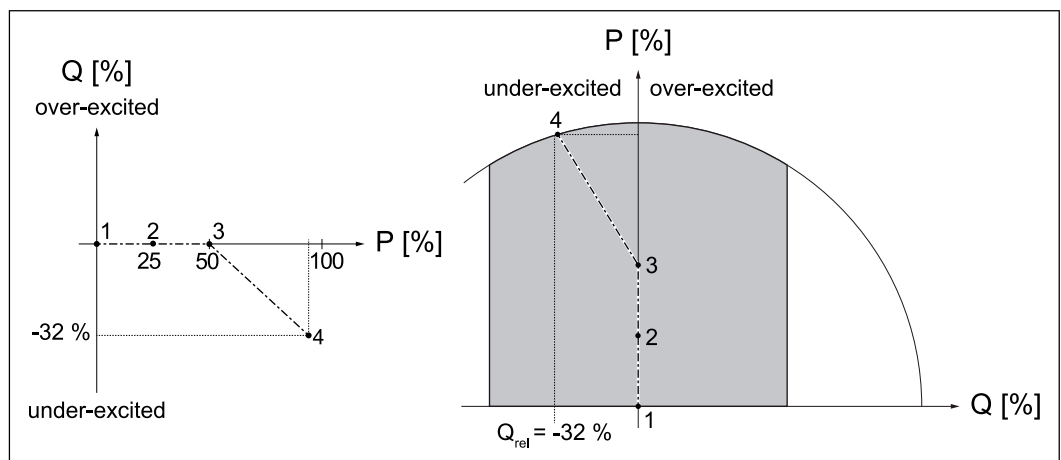

Example: Curve defined by four data points.

- 1 P = 0 %, Q = 0 %
- 2 P = 25 %, Q = 0 %

- 3 P = 50 %, Q = 0 %  
 4 P = 95 %, Q = -32 %

In addition to the four points, the following parameters also come into play:

Parameter	Range of values	Description	Supplementary description
"Lock-In Voltage-Dependent (% of Nominal Voltage)"	0 % - 120 %	AC voltage as a percentage of the nominal voltage. If this value is exceeded, the Q(P) characteristic is activated.	With the voltage-dependent Lock-In/Lock-Out values, it can be set that the Q(P) control is deactivated at low voltages.
"Lock-Out Voltage-Dependent (% of Nominal Voltage)"	0 % - 120 %	AC voltage as a percentage of the nominal voltage. If this value is undershot, the Q(P) characteristic is deactivated. The lock-out limit has priority over the lock-in limit.	The different values for activation (Lock-In) and deactivation (Lock-Out) enable a hysteresis to avoid unintentionally frequent switching on/off of the function. For this, the Lock-In value must be greater than the Lock-Out value.
"Lock-Out P-Dependent (% of Nominal Apparent Power)"	0 % - 100 %	Effective power as a percentage of the nominal apparent power $S_N$ . If this value is undershot, the Q(P) characteristic is deactivated.	With the effective power-dependent lock-out values, it can be set that the Q(P) control is deactivated at low active powers. For characteristic curves with a reactive power not equal to 0 % at data point 1, a reactive power of 0 % is approached again when this effective power value is undershot. Otherwise, in the case of effective powers which are lower than defined in data point 1, the reactive power belonging to data point 1 remains active.

Parameter	Range of values	Description	Supplementary description
"Time Constant ( $\tau$ )"	0.01 s - 60 s	Time constant (1 Tau) in seconds [s]. Whenever the set value is changed, this new set value is not triggered abruptly, but smoothly in accordance with a PT1 response. The time constant describes how quickly the new set value is reached. (After three time constants the final value 95 % is reached)	

### Q(U) - Voltage-dependent Reactive Power Characteristic

This function controls the reactive power as a function of the momentary mains voltage according to a characteristic curve. The characteristic curve is defined by four data points (1-2-3-4). If fewer data points are required, the identical parameters can be set for two points. The function is limited by the maximum apparent power and by "**Cos  $\phi$  Minimum**". For the characteristic curves, the data points in the X-axis (voltage) and in the Y-axis (reactive power) must be entered.

Point	Parameter	Range of values	Description
1	"Voltage (% of Nominal Voltage)"	50 % - 150 %	AC voltage as a percentage of the nominal voltage (X-axis).
	"Reactive Power (% of Nominal Apparent Power)"	-100 % - 100 %	Reactive power as a percentage of the nominal apparent power $S_n$ (Y-axis).
2	"Voltage (% of Nominal Voltage)"	50 % - 150 %	AC voltage as a percentage of the nominal voltage (X-axis).
	"Reactive Power (% of Nominal Apparent Power)"	-100 % - 100 %	Reactive power as a percentage of the nominal apparent power $S_n$ (Y-axis).
3	"Voltage (% of Nominal Voltage)"	50 % - 150 %	AC voltage as a percentage of the nominal voltage (X-axis).
	"Reactive Power (% of Nominal Apparent Power)"	-100 % - 100 %	Reactive power as a percentage of the nominal apparent power $S_n$ (Y-axis).

Point	Parameter	Range of values	Description
4	"Voltage (% of Nominal Voltage)"	50 % - 150 %	AC voltage as a percentage of the nominal voltage (X-axis).
	"Reactive Power (% of Nominal Apparent Power)"	-100 % - 100 %	Reactive power as a percentage of the nominal apparent power $S_n$ (Y-axis).

### General

In addition to the four points, the following parameters also come into play:

Parameter	Range of values	Description	Supplementary description
"Offset Factor"	-1 - 1	Shift of the Q(U) characteristic on the Y-axis (Q-axis) via an offset factor. The offset factor is related to the reactive power set in point 1 or point 4, by which the characteristic curve continues to be limited.	
"Initial Delay Time"	0 s - 60 s	Start-up delay in seconds [s] - Delays the start of the Q(U) control when leaving the voltage range between the data point 2 and the data point 3.	
"Lock-In P-Dependent (% of Nominal Apparent Power)"	0 % - 120 %	Effective power as a percentage of the nominal apparent power $S_n$ . If this value is exceeded, the Q(P) characteristic is activated.	With the power-dependent Lock-In/ Lock-Out values, it can be set that the Q(U) control is deactivated at low powers.
"Lock-Out P-Dependent (% of Nominal Apparent Power)"	0 % - 100%	Effective power as a percentage of the nominal apparent power $S_N$ . If this value is undershot, the Q(P) characteristic is deactivated. The lock-out limit has priority over the lock-in limit.	The different values for activation (Lock-In) and deactivation (Lock-Out) enable a hysteresis to avoid unintentionally frequent switching on/off of the function. For this, the Lock-In value must be greater than the Lock-Out value.

Parameter	Range of values	Description	Supplementary description
"Time Constant ( $\tau$ )"	0.01 s - 60 s	Time constant (1 Tau) in seconds [s]. Whenever the set value is changed, this new set value is not triggered abruptly, but smoothly in accordance with a PT1 response. The time constant describes how quickly the new set value is reached. (After three time constants the final value 95 % is reached)	

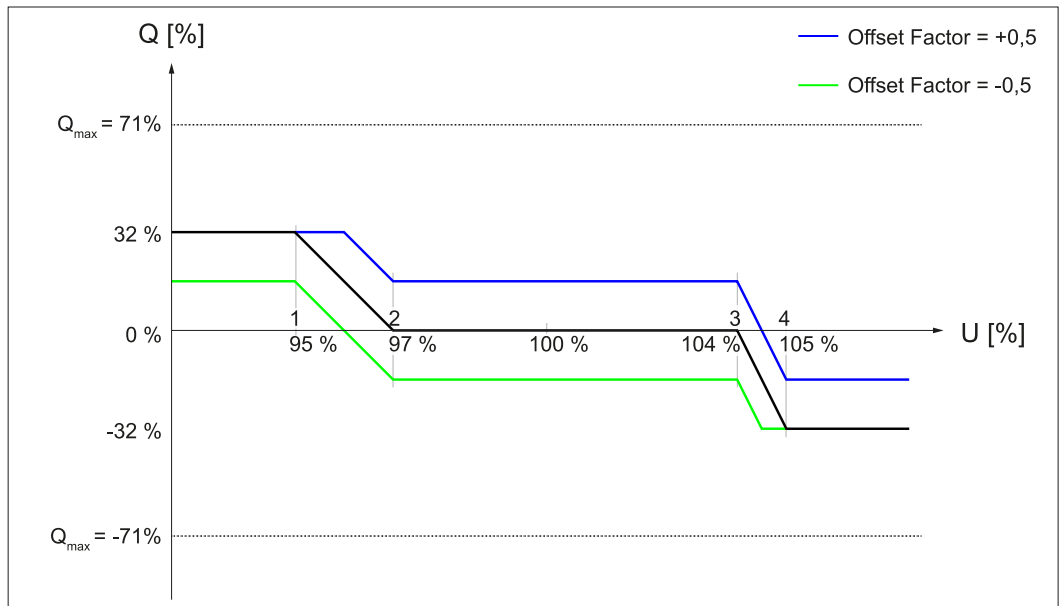

Shift of the Q(U) characteristic on the Y-axis (Q-axis) via an offset factor.

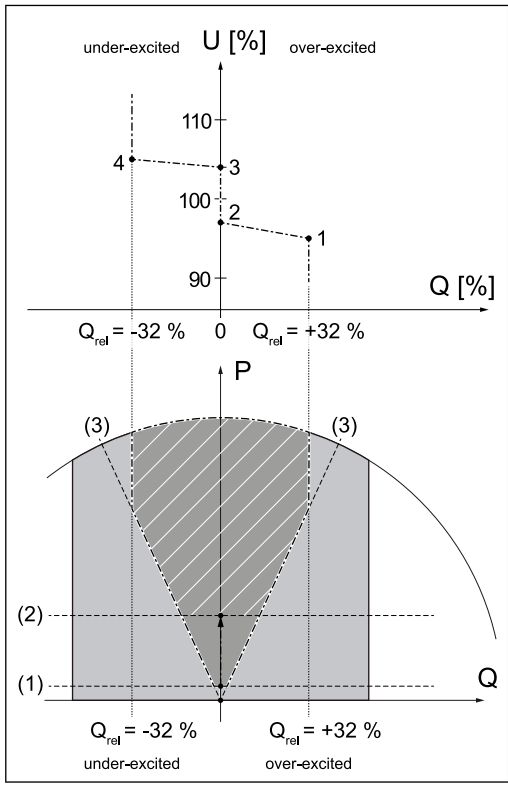

- 1  $U = 95\%$ ,  $Q = 32\%$
- 2  $U = 97\%$ ,  $Q = 0\%$
- 3  $U = 104\%$ ,  $Q = 0\%$
- 4  $U = 105\%$ ,  $Q = -32\%$
- (1) Lock-Out P-Dependent (% of Nominal Apparent Power) = 5 %
- (2) Lock-In P-Dependent (% of Nominal Apparent Power) = 30 %
- (3)  $\cos \varphi$  minimum = 0.9

Example: Curve defined by four data points.





[fronius.com/en/solar-energy/installers-partners/products-solutions/monitoring-digital-tools](https://fronius.com/en/solar-energy/installers-partners/products-solutions/monitoring-digital-tools)

**MONITORING &  
DIGITAL TOOLS**

**Fronius International GmbH**

Froniusstraße 1  
4643 Pettenbach  
Austria  
[contact@fronius.com](mailto:contact@fronius.com)  
[www.fronius.com](http://www.fronius.com)

At [www.fronius.com/contact](http://www.fronius.com/contact) you will find the contact details of all Fronius subsidiaries and Sales & Service Partners.